



LIGHTING DESIGN GUIDELINES

for the Colorado Department of Transportation

Submitted by

CLANTON & ASSOCIATES



LIGHTING DESIGN AND ENGINEERING

CONTENTS

1.	Introduction	2
1.1	Guideline Overview	2
1.2	When to Use This Guideline	3
1.3	Lighting Selection	3
2.	Lighting Applications.....	4
2.1	Rural vs. Urban Lighting.....	4
2.2	Special Lighting Applications	5
2.2.1	Freeways, Viaducts, and Flyovers	6
2.2.2	Complete Interchanges.....	8
2.2.3	Partial Interchanges.....	10
2.2.4	Highway Underpasses	12
2.2.5	Tunnels.....	13
2.2.6	Roundabouts	16
2.2.7	Unincorporated Streets.....	17
2.2.8	Pedestrian and Bicycle Pathways	19
2.2.9	Crosswalks	21
2.2.10	CDOT Park and Ride facilities	23
2.2.11	Rest Areas.....	25
2.2.12	Chain-up and Chain-down Areas	27
2.2.13	Solar Roadway Lighting	29
2.2.14	Temporary Roadway Lighting	30
2.2.15	Temporary Construction Lighting	32
2.2.16	Political Boundary Sign Lighting.....	33
3.	Lighting Controls	35
3.1	Dimming	35
3.2	Photocontrol Receptacles and Control Nodes.....	35
3.3	Lighting Control Centers and Meter Power Pedestals	36
4.	Lighting Fundamentals	37
4.1	Visibility.....	37
4.2	Common Luminaire Classifications	42
4.3	BUG Ratings.....	42
4.4	Lighting Equipment	43
4.5	Design Configurations.....	45
4.6	Pedestrian Area Classification	47
4.7	Calculation Parameters.....	47
4.8	Maintenance and Economics	49
5.	Glossary and References	50
5.1	Glossary	50
5.2	References	55



1. INTRODUCTION

The CDOT Lighting Design Guidelines represent the current recommended practices for roadway lighting and includes criteria for typical applications found in the State of Colorado. It is based on the Illuminating Engineering Society (IES) Lighting Handbook Tenth Edition, the American National Standard Practice for Design and Maintenance of Roadway and Parking Facility Lighting (ANSI/IES RP-8-18), and the American Association of State Highway and Transportation Officials (AASHTO) 2005 Roadway Lighting Design Guide. The CDOT Lighting Design Guidelines should be used in conjunction with the latest version of these references. Exceptions to these guidelines should be thoroughly evaluated and documented in accordance with CDOT’s design exception policies.

The guidelines were developed, prepared, and reviewed in 2019 by Clanton and Associates, Inc. and a team of CDOT engineers representing all CDOT regions.

Comments on this Design Guide may be sent to
Colorado Department of Transportation
Traffic and Safety Engineering Branch
2829 W. Howard Pl.
Denver, Colorado 80204
303-757-9654

The lighting justification listed in these guidelines are taken from the AASHTO Roadway Lighting Design Guide lighting warrants. The meeting of AASHTO lighting warrants does not obligate the Department to undertake a lighting project on either existing or proposed highways. The justification for lighting should be based on conditions relating to the need for roadway lighting and the benefits that may be derived from lighting.

These guidelines use standard US Customary units (inch-foot-mile). One exception to this format is made when discussing candela / square meter (cd/m^2), the unit of lighting luminance. The English term for this unit, footlamberts, is no longer current in the lighting industry. While this is inconsistent with the other US Customary units, all luminance criteria are given in cd/m^2 .

1.1 GUIDELINE OVERVIEW

The purpose of roadway lighting is to improve nighttime visibility by lighting roadway conflict points, pedestrians in crosswalks, fixed objects, or obstructions on the roadway. A good lighting system that can improve nighttime visibility will have effective, high quality light of an appropriate quantity

with minimal glare. Effective lighting refers to the ability of the light to provide contrast between objects and surroundings so that motorists can detect conflicts in time to take evasive action.

The roadway lighting system design is based on pavement luminance. Luminance is defined as the amount of light reflected from a surface that the eye perceives (in cd/m^2). More specifically, pavement luminance refers to how bright the pavement appears. Luminance quantifies the visual environment with respect to how a motorist will view it. Another metric used in roadway lighting design is illuminance, which is defined as the amount of light that reaches a surface, in footcandles (fc). Curving roadway sections, such as partial interchanges, are based on illuminance due to calculation software limitations. Intersections and pedestrian pathways are also based upon illuminance, both horizontal and vertical. Illuminance, while easy to calculate and an initial starting point in the design process, does not quantify what a motorist sees and is not used as the lighting criteria in most roadway applications.

In addition to providing adequate visibility, roadway lighting design must address the importance of operation and maintenance. Typical operation and maintenance issues includes life of the light source, durability of the luminaire, access to the luminaire due to both location and height of the light standard, and availability of replacement parts. Some control systems can simplify the maintenance process by providing real time analytics of the light source and luminaire along with issuing error messages when a luminaire fails.

Chapter 4 of these guidelines offers further explanation regarding many of the lighting concepts and terminology used throughout. Chapter 5 contains a glossary of the terms used in this document. Refer to the current versions of the IES Lighting Handbook, ANSP/IES RP-8-18, and the AASHTO Lighting Guide for additional information on roadway lighting design.

1.2 WHEN TO USE THIS GUIDELINE

This guideline should be used for all CDOT owned and maintained lighting installations. For lighting projects with CDOT oversight, the designer should first consider the lighting requirements, both criteria and equipment, of the entity that will be owning and maintaining the lighting equipment. If this guideline is more stringent than the controlling entity, this guideline should be followed. For instance, if the entity has high or no glare criteria, the design should follow these guidelines for minimizing glare. These design guidelines may also be used in the absence of lighting criteria or lighting equipment requirements.

1.3 LIGHTING SELECTION

Any luminaire specified on a CDOT roadway project must satisfy the luminaire specifications and LED dimmable driver specifications outlined in Section 613 and 715 of CDOT Standard Specifications.

Coordinate with the CDOT Project Manager about CDOT's three name specification requirements prior to beginning the lighting design.

Chapter 2



2. LIGHTING APPLICATIONS

The following application pages outline when lighting is justified, the performance criteria to meet, and best practices to provide the designer with a starting point for the design with an overall view of the design objectives. Special considerations for each application are also listed. Example designs are illustrated to show how the criteria may be met for a given case; they cannot be taken as a standard. All designs should be treated individually.

The criteria and examples assume a simple layout such as straight, horizontal stretches of roadway. For sharp curves, steep hills, or any special case consult the latest version of the Manual of Uniform Traffic Control Devices (MUTCD), IES Lighting Handbook, ANSP/IES RP-8-18, or AASHTO Design Guide.

2.1 RURAL VS. URBAN LIGHTING

The designer should consider the ambient conditions (rural, mountainous and/or urban) of the project area when applying the lighting criteria for a given application. The performance criteria outlined in this guideline is appropriate for areas with minor to moderate anticipated pedestrian activity. This guideline does not consider areas of high pedestrian activity, which would be typical in a downtown district within a city. The city's lighting criteria should be applied in these situations.

If the lighting application is in a rural ambient lighting environment with little or no anticipated pedestrian activity, the designer may provide justification for deviating from the performance criteria. Power is not available in some rural areas, making it impractical to provide electrical service for roadway lighting. In these locations, solar or wind powered streetlights should be considered; or if there are no anticipated pedestrians, minimal vehicular traffic, and the posted speed is below 30 mph then lighting may not be necessary. The designer and CDOT project manager are responsible for discussing whether lighting is needed on such stretches of roadway.

RURAL OR MOUNTAINOUS AMBIENT LIGHTING ENVIRONMENT

These areas typically include cities, towns, counties, residential communities, locations in the mountains or eastern plains, and open space areas with low ambient light levels. Due to the naturally low ambient nighttime lighting level, installing high intensity luminaires (B3-U0-G3 or greater BUG ratings per IES TM-15-11) that output too much light for the application, or do not meet the glare ratings, can negatively impact nighttime visibility. When the lighting application is

in an area with low ambient lighting levels, the designer should consider installing warmer correlated color temperature lighting (2700K or less) with low BUG ratings (B1-U0-G2 or less) to better integrate with existing conditions.

URBAN AMBIENT LIGHTING ENVIRONMENT

Urban environments typically include moderate pedestrian activity commercial areas, hospitals, or regional transportation stops that may require increased ambient lighting levels due to the number of pedestrians using the area. Installing insufficient lighting in these areas may decrease nighttime visibility since objects are not properly lighted to improve object contrast which could result in the objects blending into the background.

2.2 SPECIAL LIGHTING APPLICATIONS

The following sections provide a summary for each of the given lighting applications including lighting justification, criteria, and special considerations.

The roadway lighting criteria found in the Lighting Applications varies by street classification and anticipated amount of pedestrian activity. Refer to Chapter 4 for a glossary of terms used in this guideline.

LIGHTING APPLICATIONS TABLE OF CONTENTS

2.2.1	Freeways, Viaducts, and Flyovers	6
2.2.2	Complete Interchanges	8
2.2.3	Partial Interchanges.....	10
2.2.4	Highway Underpasses.....	12
2.2.5	Tunnels	13
2.2.6	Roundabouts.....	16
2.2.7	Unincorporated Streets.....	17
2.2.8	Pedestrian and Bicycle Pathways.....	19
2.2.9	Crosswalks.....	21
2.2.10	CDOT Park and Ride facilities	23
2.2.11	Rest Areas	25
2.2.12	Chain-up and Chain-down Areas.....	27
2.2.13	Solar Roadway Lighting.....	29
2.2.14	Temporary Roadway Lighting.....	30
2.2.15	Temporary Construction Lighting.....	32
2.2.16	Political Boundary Sign Lighting	33

2.2.1 FREEWAYS, VIADUCTS, AND FLYOVERS

Definitions

- Freeway: A divided highway with full control access.
 - Freeway A: a highway with visual complexity and high traffic volumes.
 - Freeway B: all other highways.
- Viaduct: A long bridge-like structure carrying a road across a valley or other low ground.
- Flyover: A high-level overpass built above main overpass lanes, or a bridge built over an at-grade intersection.

When to Light

Lighting should be considered when the freeway is in or adjacent to a lighted development or city. When adjacent lights are visible from an unlighted roadway, it can make adaptation difficult, which may diminish nighttime visibility. Lights should be considered to improve nighttime visibility and minimize contrast of shadows on the roadway to improve motorist navigation at night. In many areas non-continuous partial interchange lighting is sufficient for Freeway B applications. Continuous lighting may be justified when the following conditions exist:

- The adjacent area is substantially urban.
- The freeway is in or near a city where the present average daily traffic (ADT) is 30,000 vehicles or more.
- There are three or more successive interchanges with an average spacing of 1.5 miles or less.
- The crossroad is lighted for at least 0.5 miles on each side of the interchange.
- Lighting is recommended on crossroad ramp terminals when there are raised channelizing islands or when sight distance is poor.

Lighting Criteria

Lighting levels will be considered as meeting the criteria if the calculated values are within ten percent (10%) of the criteria or do not exceed the criteria by more than two times (2x).

Roadway Type	Freeway A Average Luminance (cd/m ²)	Freeway B Average Luminance (cd/m ²)	Average Uniformity (avg:min)	Maximum Luminance Ratio (LV _{max} :L _{avg})
Freeways	0.6	0.4	4	0.3
Viaducts	0.6	0.4	4	0.3
Flyovers	0.6	0.4	4	0.3

Best Practices

- Mounting height: typically, 30 to 70 feet.
 - Mid mast light standards (40 feet to 70 feet) are typically installed on large roadway projects; these light standards are typically median mounted to light the entire roadway.
 - CDOT no longer installs high mast lights on new projects.
- Light Distribution:
 - Begin with a Type II or Type III distribution without any uplight (U0). Other distributions may be considered depending on the roadway design and light standard location.
 - A Type IV distribution may be appropriate when light standards are set further away from the roadway than typical, or the roadway has more than 5-lanes for traffic.
- Spacing: begin with a 6:1 spacing to mounting height ratio. Modify accordingly to meet lighting criteria and other critical design issues.

Special Considerations

Illuminance calculations can be used to design curves and short steep hills. The atypical section of roadway should meet the same illuminance value as a straight section of roadway. With lighting calculation software, the straight roadway illuminance value can be calculated at the same time as the roadway luminance value.

- Curves typically require closer spacing of standards.
- Short steep hills may require closer spacing of standards.
- Some viaducts and flyovers may require alternative lighting solutions that limit the use of light standards.

DESIGN EXAMPLES

Figure 1: Typical Freeway Design, Plan View

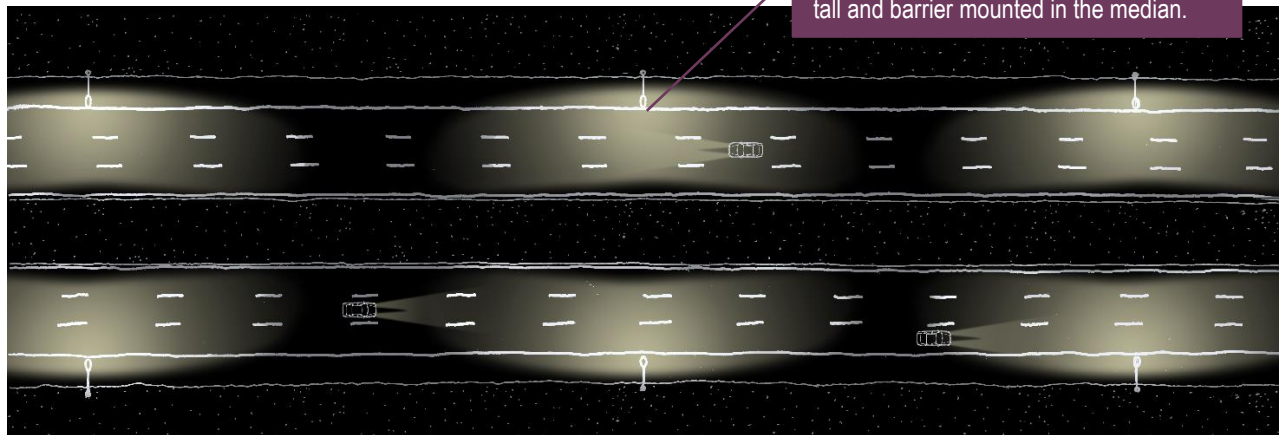

Figure 2: Alternative Flyover, Plan View

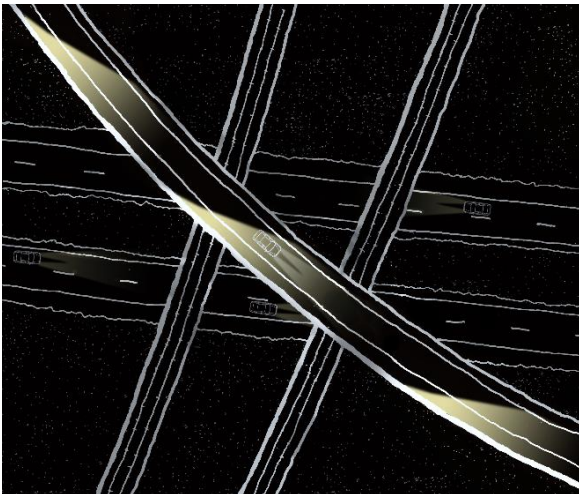
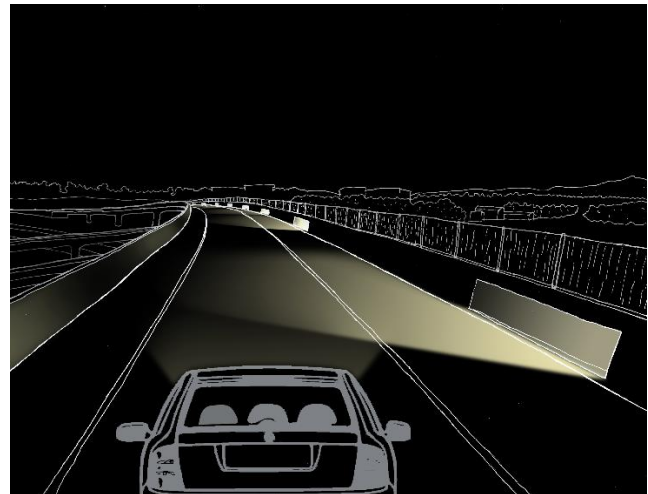

Figure 3: Alternative Flyover, Isometric View



2.2.2 COMPLETE INTERCHANGES

Complete interchange lighting provides relative uniform lighting within the limits of the interchange, including: main lanes, ramp terminals, frontage roads, or crossroad intersections.

When to Light

Interchange lighting is recommended when the local government agency is willing to pay an appreciable percentage of, or wholly finance, the lighting installation.

Complete interchange lighting should be considered when the roadway is adjacent to a lighted development or roadway. Lights should be considered to improve nighttime visibility and minimize contrast or shadows on the roadway to improve motorist navigation at night. Complete interchange lighting may be justified per the following conditions:

- There are three or more successive interchanges with an average spacing of 1.5 miles.
- The adjacent area is substantially urban.
- The crossroad is lighted for at least 0.5 miles on each side of the interchange.

Lighting Criteria

Lighting levels will be considered as meeting the criteria if the calculated values are within ten percent (10%) of the criteria or do not exceed the criteria by more than two times (2x).

Roadway Type	Freeway A Average Luminance (cd/m ²)	Freeway B Average Luminance (cd/m ²)	Average Uniformity (avg:min)	Maximum Veiling Luminance Ratio (L _{Vmax} :L _{avg})
Complete Interchanges	0.6	0.4	4	0.3

Best Practices

- Mounting height: typically, 30 to 70 feet.
 - Mid mast light standards (40 feet to 70 feet) are typically installed on large roadway projects; these light standards are typically median mounted to light the entire roadway.
 - CDOT no longer installs high mast lights on new projects.
- Light Distribution: begin with a Type III distribution without any upright (U0).
- Spacing: begin with a 5:1 spacing to mounting height ratio. Modify accordingly to meet lighting criteria and other critical design issues.
- Light standards should follow the roadway through the interchange.
- When possible, a light standard should be placed in the gore area at off-ramps.

Special Considerations

- Lights should be located on the inside of curves to minimize potential strikes from vehicles.
- Light standards present near residential neighborhoods present greater light trespass potential. Low backlight (B0 through B2) and low glare ratings (G2 or less) should be considered to minimize light trespass.

DESIGN EXAMPLES

Figure 4: Continuous Interchange, Plan View

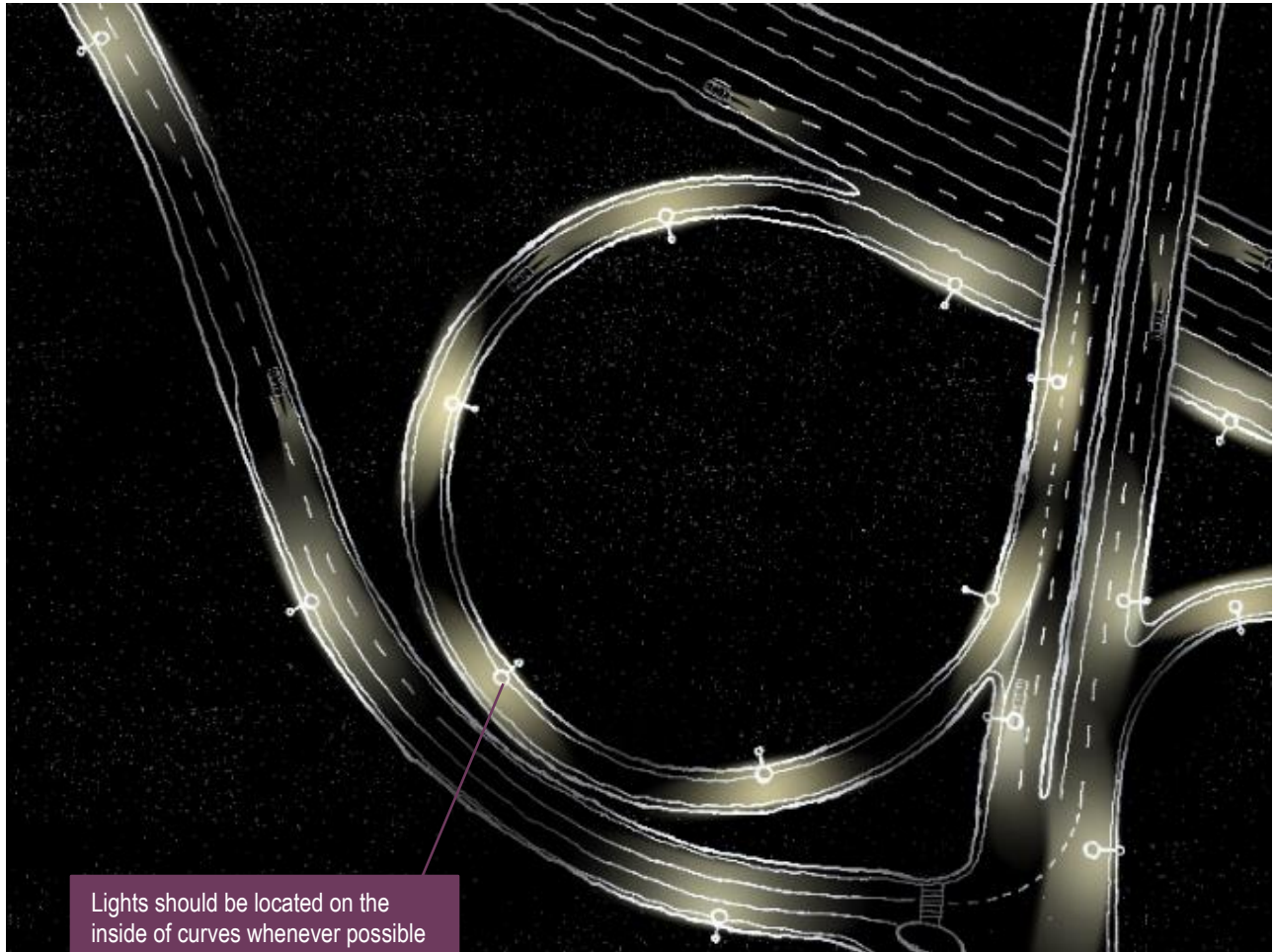

Lights should be located on the inside of curves whenever possible to minimize potential knockdowns.

2.2.3 PARTIAL INTERCHANGES

Partial interchange lighting provides illumination only on decision-making areas of roadways including: acceleration and deceleration lanes, ramp terminals, crossroads at frontage road or ramp intersections, or areas of nighttime hazard.

When to Light

Partial interchange lighting is recommended at all locations where a non-continuously lighted highway is adjacent to a lighted development or roadway. Partial interchange lighting is often sufficient for lighting Freeway B highways adjacent to local developments.

Partial interchange lighting should be considered for the following applications:

- Crossroad ramp terminals adjacent to a local development.
- Crossroad ramp terminals connecting any two of following roadway types:
 - Intersections
 - National highways
 - State highways

Lighting Criteria

Lighting levels will be considered as meeting the criteria if the calculated values are within ten percent (10%) of the criteria or do not exceed the criteria by more than two times (2x).

Street Classification	R1 (Concrete) Average Luminance (cd/m ²)	R3 (Asphalt) Average Luminance (cd/m ²)	Uniformity Ratio (avg:min)
Freeway	0.4	0.6	4
Major	0.6	0.8	4
Collector	0.4	0.6	4
Local	0.3	0.4	6

Best Practices

- Mounting height: typically, 25 to 40 feet.
- Light Distribution: begin with a Type II or Type III distribution without any uplight (U0). For narrow interchanges a Type II distribution may perform better.
- Spacing: begin with a 5:1 spacing to mounting height ratio. Modify accordingly to meet lighting criteria and other critical design issues.
- Two to four light standards are typically installed along cross ramp terminals

Special Considerations

- Light standards present near residential neighborhoods present greater light trespass potential. Low backlight (B0 or B1) and low glare ratings (G1) may be required to minimize light trespass.
- Motorists are more likely to utilize the full length of a merge/diverge lane if the lane is lighted. Motorists are more inclined to immediately merge with traffic when the lane is not lighted.

DESIGN EXAMPLES

Figure 5: Partial Interchange Lighting, Plan View

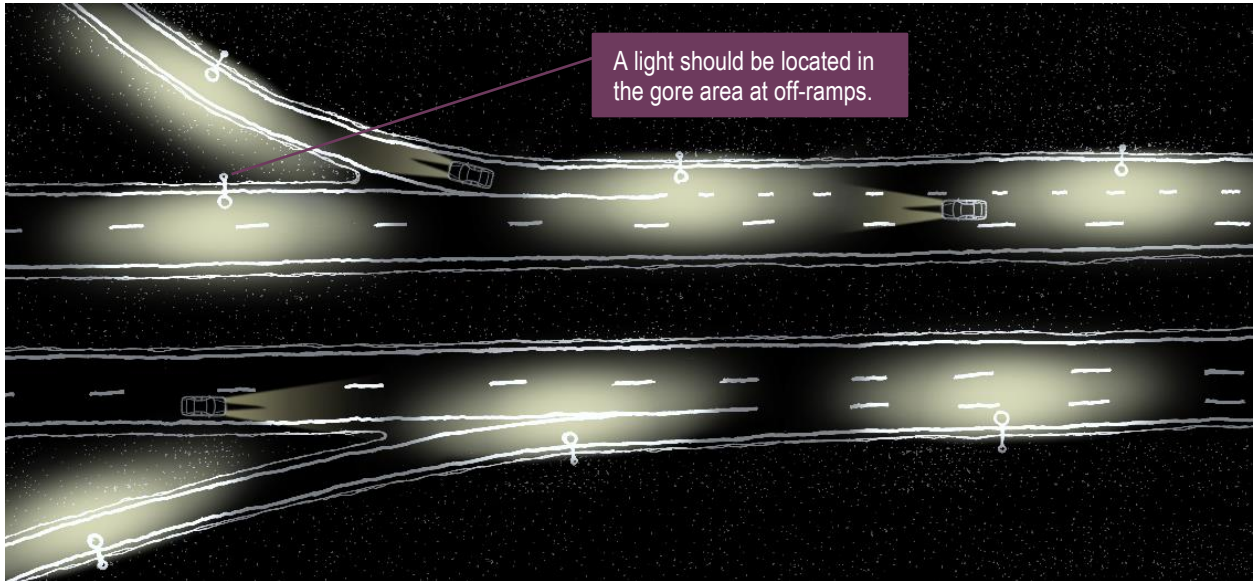

Figure 6: Partial Interchange Lighted On-Ramp, Isometric View

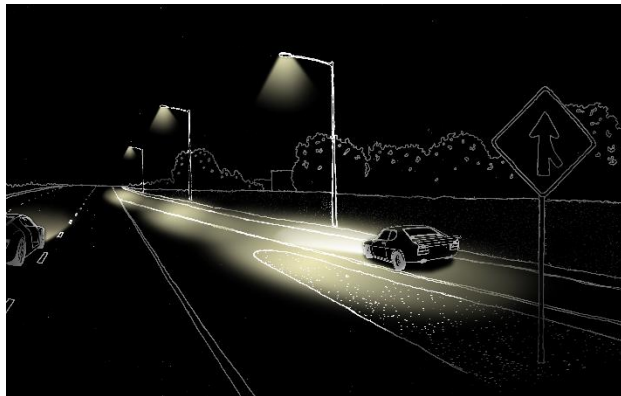
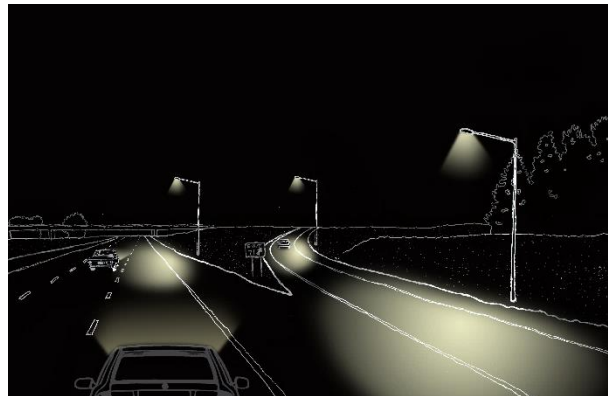

Figure 7: Partial Interchange Lighted Off-Ramp, Isometric View



2.2.4 HIGHWAY UNDERPASSES

When to Light

- Underpasses do not require nighttime lighting if the adjacent roadway is not lighted.
- Underpasses on lighted roadways should be lighted to the same luminance as the roadway.
- Underpasses less than 80 feet in length, do not require supplemental lighting for daytime adaptation.
- Underpasses between 80 feet and 410 feet in length, may require supplemental lighting for daytime adaptation. Refer to Section 2.2.5 for more information.

Lighting Criteria

Lighting levels will be considered as meeting the criteria if the calculated values are within ten percent (10%) of the criteria or do not exceed the criteria by more than two times (2x).

Street Classification	Luminance Range (cd/m ²)	Avg. Uniformity (avg:min)	Max. Uniformity (max:min)	Max. Veiling Luminance Ratio (L _{vmax} /L _{avg})
Freeway Class A	0.6	4	6	0.3
Freeway Class B	0.4	4	6	0.3

Best Practices

- Luminaire optics or shielding should be carefully considered to avoid glare for motorists.
- Whenever possible the lights should be located above the shoulder on the outside edge of the roadway to minimize traffic impacts, due to lane closure, when the luminaire is maintained.
- Controls should be installed such that all underpass lights turn on and off at the same time.

Special Considerations

- Most underpasses do not require lighting if the roadway light standards are adequately spaced and light the pavement beneath the underpass.
 - For shorter underpasses, it may be possible to locate the roadway luminaires such that sufficient light shines into the underpass without the bridge shadowing the roadway.
 - For longer underpasses, it will be necessary to install wall or ceiling mounted luminaires.
 - Use lighting calculation software to confirm whether adjacent streetlights sufficiently illuminate the underpass or if additional underpass lights are needed.
- When the length to height ratio of an underpass exceeds approximately 6:1, it should be evaluated for the need for additional daylight illumination. Refer to Section 2.2.5 Tunnels for additional information on short tunnels (underpasses with a length greater than 80 feet).

DESIGN EXAMPLES

Figure 8: Highway Underpass, Plan View

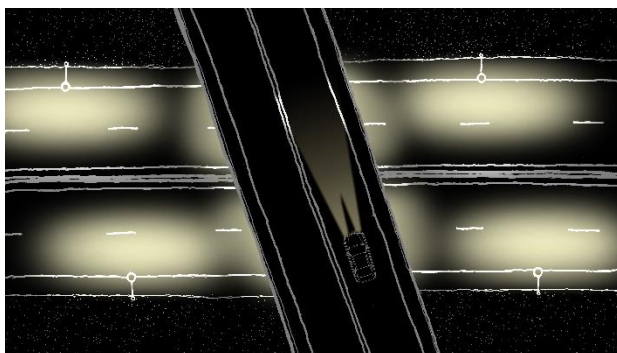
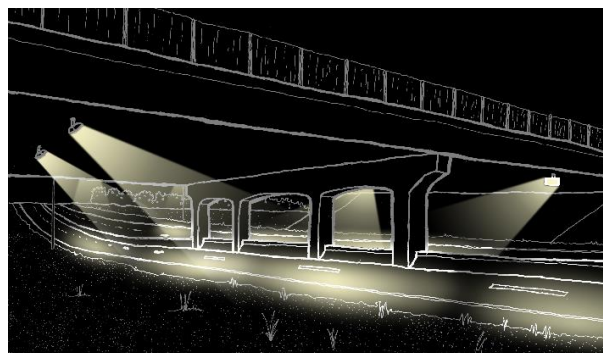

Figure 9: Highway Underpass, Isometric View



2.2.5 TUNNELS

The term “tunnel” means an enclosure roadway for motor vehicle traffic with vehicle access limited to portals, regardless of the type of structure or method of construction, that requires, based on the owner’s determination, special design considerations that may include lighting, ventilation, fire protection systems, and emergency egress capacity.

Long tunnel structures with limited daylight penetration reduce motorists’ ability to adapt to lower light levels during the daytime, within the structure. For this reason, daytime and nighttime lighting should be considered for any tunnel greater than 150 feet in length. Daytime and nighttime lighting is required for any tunnel greater than 410 feet in length.

Refer to ANSI/IES RP-8-18 *Chapter 14: Tunnel Lighting* for information on how to design the lighting system for tunnels greater than 80 feet in length.

When to Light

The type of tunnel lighting system upgrade is to be confirmed by the CDOT Project Manager.

- Existing lighting system upgrades:
 - Minor upgrades do not need to follow these guidelines.
 - Major upgrades may not need to follow these guidelines.
 - Replacement of existing lighting system should follow these guidelines.
- Condition based replacements shall refer to the CDOT Bridge Inspection – National Tunnel Inspection Specification (NTIS) Inventory for information on the lighting system condition.
- Tunnel lighting rebates may justify a lighting upgrade.

Criteria

Tunnels have both daytime and nighttime lighting criteria; refer to ANSI/IES RP-8-18 *Chapter 14: Tunnel Lighting* for complete design criteria. Apply the L_{seq} method to determine the appropriate pavement luminance.

Factors influencing lighting design criteria include:

- Bi-directional (undivided) or divided tunnel traffic direction. Confirm with the CDOT Project Manager to see if a bi-directional lighting design is necessary for tunnel maintenance bore closures.
- AASHTO Stopping Sight Distance varies by speed and roadway grade.
- Threshold zone lighting criteria is dependent on the:
 - Tunnel portal solar orientation and surrounding geometry.
 - Tunnel length, traffic volume, wall reflectance, daylight penetration, and visibility of the portal.
- The ratio between the average illuminances of the pavement and wall should not exceed 2.5:1.
- The luminaire shall be tested per, and meet, the following requirements:

Tunnel Luminaire Requirements	
Correlated color temperature (CCT)	4000K within the tunnel
Salt spray test per ASTM B117	1000 hours, minimum
Vibration rating per ANSI C136.31	3G
IP rating per IEC 60598	IP66
Ambient operation temperature	-40°C to +40°C
Photometric testing	IES LM-79 and IES LM-80

- Refer to NFPA 502 for emergency lighting considerations. Since NFPA has not been officially adopted by the State of Colorado, at this time, consult with the CDOT Project Manager to determine which measures in NFPA 502 will be applied to the tunnel.

Best Practices

- The tunnel preliminary design documents should include an evaluation of the existing conditions of the tunnel elements associated with the tunnel systems (luminaires, conduit, electrical wiring, lighting control system, etc.).
- On-site tunnel measurements should be taken per IES LM-71-14 *Photometric Measurement of Tunnel Lighting Installations*.
- Tunnel Maintenance and Operations should be consulted about:
 - The tunnel cleaning schedule,
 - The existing lighting system utility costs, and
 - Desires for adding assets to the inventory.
- Avoid flicker and luminaire frequency between the range of 4 Hz to 11 Hz per the frequency analysis based on the luminaire spacing and design speed.
- The tunnel pavement and wall lighting levels should be calculated using AGi32 or equivalent lighting calculation software.
- Refer to the International Commission on Illumination (CIE) *Guide for the Lighting of Road Tunnels and Underpasses, 2nd Edition* for additional information on tunnel lighting systems.

Special Considerations

- Luminaire maintenance is especially difficult in tunnels. Consult with the Project Manager and Tunnel Maintenance and Operations to determine where new hardware should be installed in the tunnel for future ease of maintenance.
- CDOT maintenance store rooms should be notified of new tunnel luminaire stock.
- Coordinate with the CDOT Project Manager about CDOT's three name specification requirements prior to beginning the lighting design.

DESIGN EXAMPLES

Figure 10: Daytime Tunnel, Plan View (Bi-directional Bore)

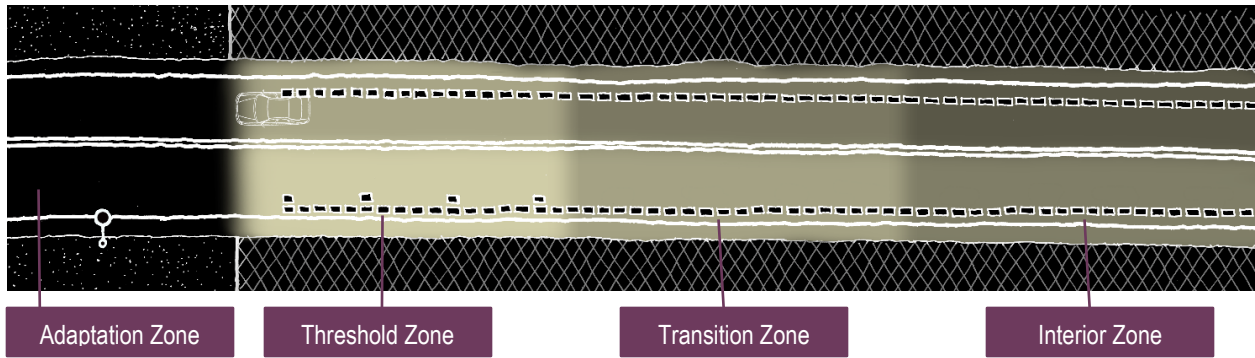
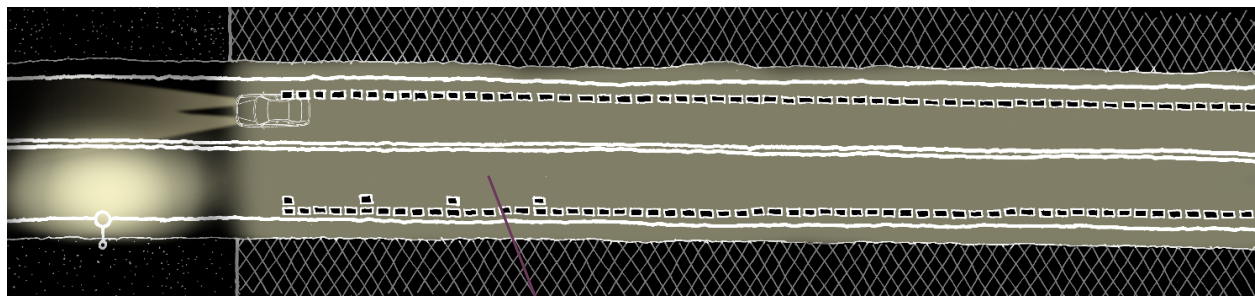
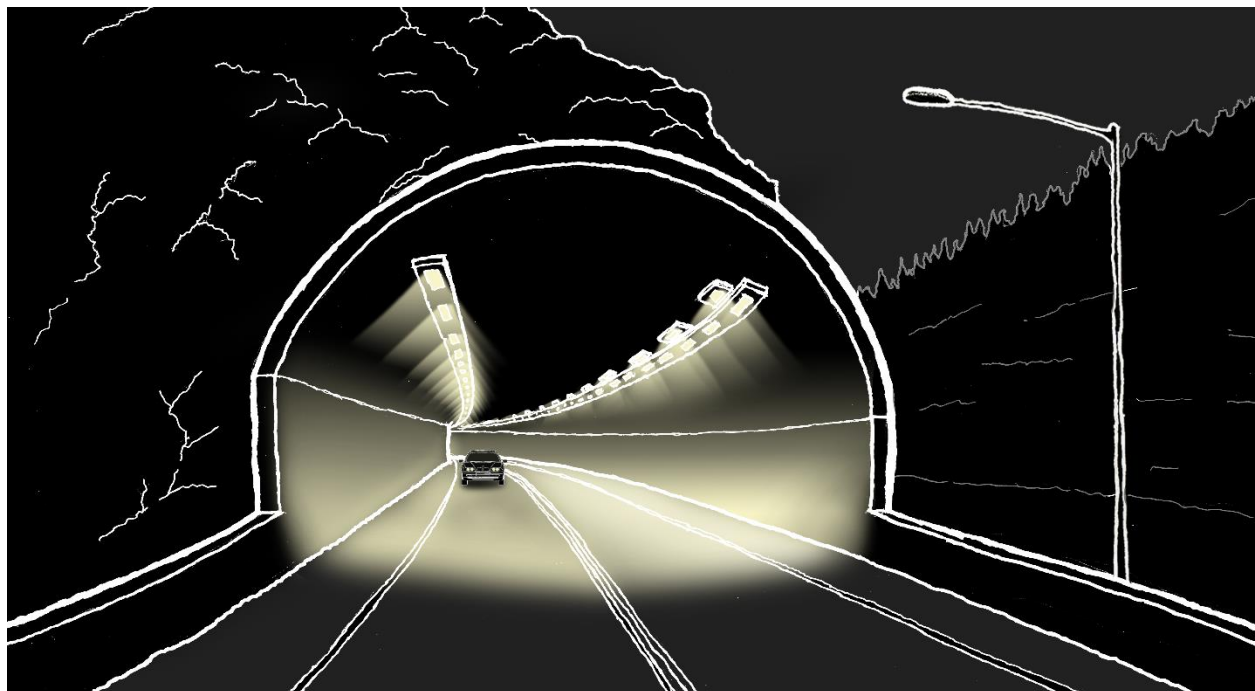

Figure 11: Nighttime Tunnel, Plan View (Bi-directional Bore)



The entire tunnel should be lighted to the Interior Zone lighting level, but no more than 3x the approach roadway lighting level.

Figure 12: Daytime Tunnel, Isometric View (Bi-directional Bore)



2.2.6 ROUNDABOUTS

When to Light

- Lighting should be considered at all roundabouts with pedestrian usage and adjacent electrical service.
- See ANSI/IES RP-8-18 *Chapter 12* for additional roundabout design information.
- See Section 2.2.9 for information about lighting crosswalks.

Lighting Criteria

Lighting levels will be considered as meeting the criteria if the calculated values are within ten percent (10%) of the criteria or do not exceed the criteria by more than two times (2x).

Intersecting Roads	Average Illuminance with minimal pedestrian activity (fc)	Average Illuminance with anticipated pedestrian activity (fc)	Uniformity (avg:min)
Major/Major	1.7	2.4	3
Major/Collector	1.4	2.0	3
Major/Local	1.2	1.9	3
Collector/Collector	1.1	1.7	4
Collector/Local	0.9	1.5	4
Local/Local	0.7	1.3	6

Best Practices

- Light standards should not be located in the center of the roundabout.
- Locate light standards on the approach side of each entry such that the maximum amount of vertical light falls on vehicles entering the roundabout and on crosswalks when present.
- Approach lighting should be considered for a minimum of 400 feet in front of the roundabout.
- Light standards should be located at least 4 feet (6 feet is preferred) away from the front edge of the curb to minimize the chance of the pole being struck by a vehicle.

Special Considerations

- Lighted features in the center of the roundabout may increase the ambient brightness. Care must be given to not cause glare for any of the motorists.

DESIGN EXAMPLES

Figure 13: Roundabout, Plan View

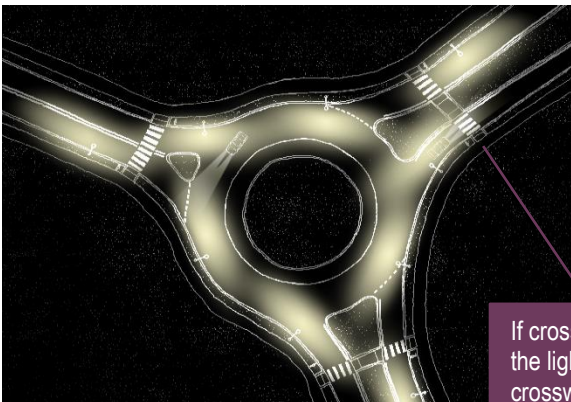
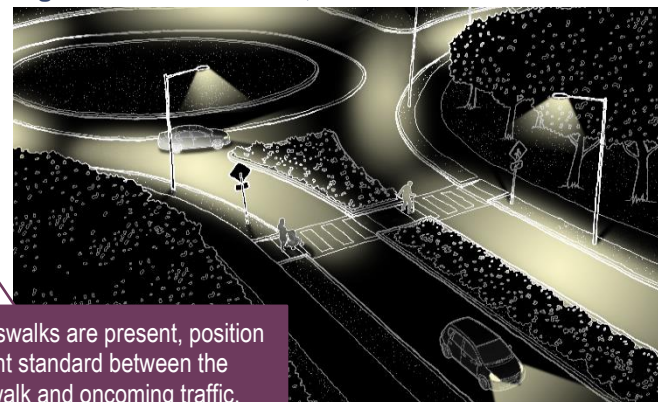

Figure 14: Roundabout, Isometric View



If crosswalks are present, position the light standard between the crosswalk and oncoming traffic.

2.2.7 UNINCORPORATED STREETS

Any roadway lighting within the jurisdictional boundary of a municipality or metropolitan “metro” district governed by the county is the responsibility of the municipality or metro district. The responsible agency’s guidelines should be used. Refer to CDOT’s jurisdictional boundary agreements for more information.

Unincorporated areas that fall under CDOT’s jurisdiction should meet the requirements listed in these guidelines.

When to Light

Lighting should be considered if any of the following conditions exist:

- The local development/ government is willing to maintain and/or finance the lighting installation.
- Posted speed limits are equal to or greater than 30 mph.
- The roadway design includes conflict points such as merge or diverge lanes, roundabouts, intersections, or crosswalks.

Lighting Criteria

Lighting levels will be considered as meeting the criteria if the calculated values are within ten percent (10%) of the criteria or do not exceed the criteria by more than two times (2x).

Street Classification	Average Luminance with minimal pedestrian activity (cd/m ²)	Average Luminance with anticipated pedestrian activity (cd/m ²)	Average Uniformity (avg:min)	Maximum Veiling Luminance Ratio (L _{vmax} /L _{avg})
Major	0.6	0.9	4	0.3
Collector	0.4	0.6	4	0.4
Local	0.3	0.5	6	0.4

Best Practices

- Mounting height: typically, 20 to 40 feet.
- Light Distribution: begin with a Type II or Type III distribution without any uplight (U0). For narrow roadways a Type II distribution may perform better. For single sided light standard installation, a Type IV distribution may adequately light both directions of traffic.
- Spacing: Begin with a 5:1 spacing to mounting height ratio. Modify accordingly to meet lighting criteria and other critical design issues.
- When possible locate the light standard 4 feet to 6 feet behind the front face of curb per AASHTO to protect the light standard from oncoming vehicles.

Special Considerations

- Some developments may choose to fully finance and maintain architectural style luminaires. When this is the case the designer should:
 - Check with impacted development to understand their local standards and aesthetics.
 - Ask if accessories are required for development owned light standards such as banner arms, signs, and seasonal lighting receptacles. Size the light standard and electrical requirements accordingly.
- Low backlight (B1 or less) and low glare ratings (G1 or less) may be required near residential neighborhoods to minimize light trespass and glare.
- Refer to Section 3.3.9 for crosswalk design considerations.

DESIGN EXAMPLES

Figure 15: Example 1 Intersection, Plan View

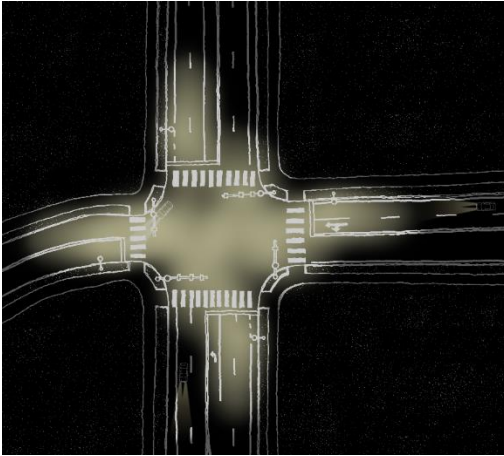

Figure 16: Example 2 Mid-block crossing, Plan View

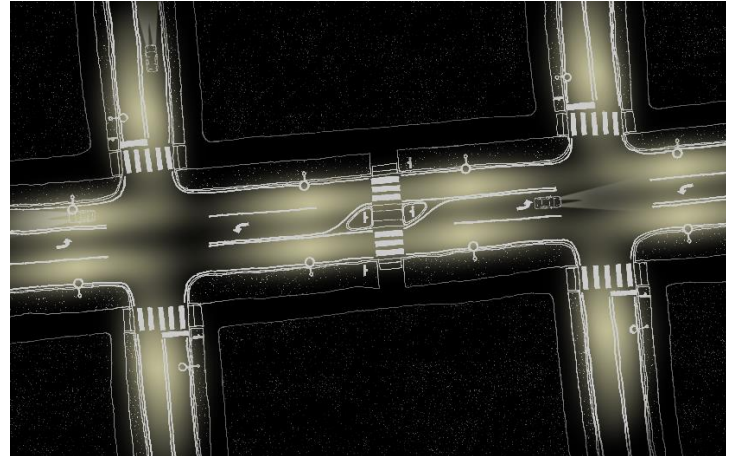
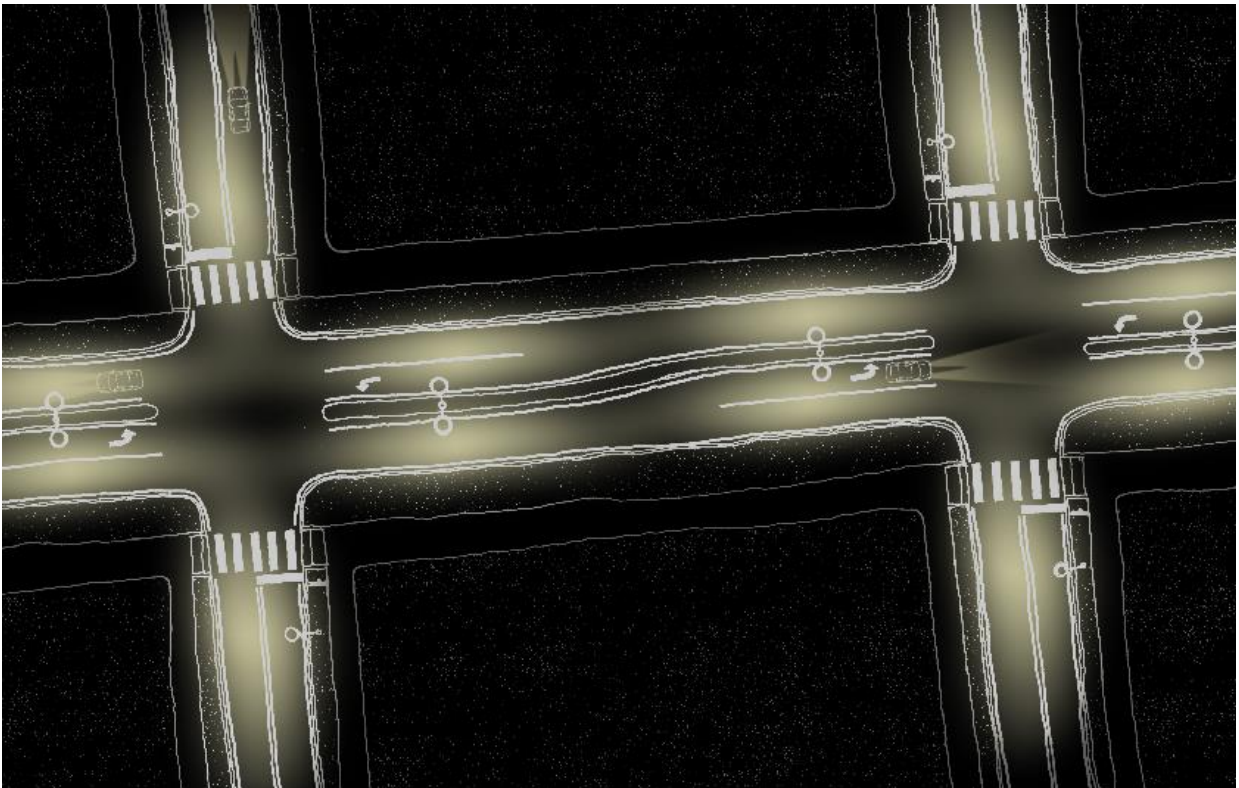

Figure 17: Median Mounted Roadway Lighting, Plan View



2.2.8 PEDESTRIAN AND BICYCLE PATHWAYS

When pedestrian areas fall within the jurisdictional boundary of a municipality or metro district, the governing municipality is responsible for the lighting. Lighting of pedestrian areas outside the roadway limits will always be the responsibility of the local agency.

When to Light

Lighting should be considered at conflict points in pedestrian or bicycle pathways with adjacent electrical service.

- Stairs and access ramps,
- Pedestrian underpasses, and
- Conflict points along pathways with anticipated pedestrian traffic during darkness hours.

Lighting Criteria

Lighting levels will be considered as meeting the criteria if the calculated values are within ten percent (10%) of the criteria or do not exceed the criteria by more than two times (2x).

Conflict Type	Average Horizontal Illuminance (fc)	Average Vertical Illuminance (fc)	Horizontal Uniformity (avg:min)
Average illuminance with anticipated pedestrian activity	0.5	0.2	4
Average illuminance with minimal pedestrian activity	0.2	0.1	10

Best Practices

- Pedestrian luminaire mounting height: typically, 10 to 15 feet. A mounting height of 12 feet is the most common.
- Spacing: Begin with a 5:1 spacing to mounting height ratio. Modify accordingly to meet lighting criteria and other critical design issues.
- Pedestrian underpasses are typically lighted with a wall or ceiling mounted luminaire spaced 15 feet to 30 feet on center. Approach lighting (pedestrian light standards, bollards, step lights, or wall mounted lights) should be considered when the grade drastically changes before the entrance to a pedestrian underpass.

Special Considerations

- Pedestrian luminaires adjacent to residential properties should be shielded to minimize light trespass and glare. B1-U1-G1 maximum BUG ratings are recommended.
- Attached sidewalk illumination is often provided by adjacent roadway lighting. Consideration should be given to adequate sidewalk illumination when a roadway lighting system is designed. For example, opposed luminaire arrangements provide better sidewalk lighting than median mounted systems.
- Careful attention should be paid to vertical illumination levels. Vertical illuminance is important for identifying approaching pedestrian's intent to enhance the sense of safety.
- When the pedestrian underpass is lighted, the lights should remain on during daytime hours to provide some adaptation from daylight to the darker interior.

DESIGN EXAMPLES

Figure 18: Bike Path, Isometric View

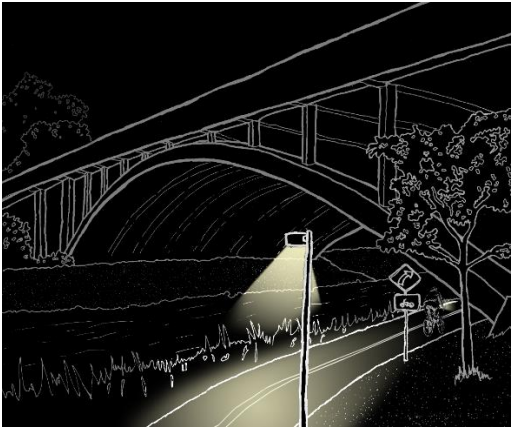

Figure 19: Pedestrian Bridge, Isometric View

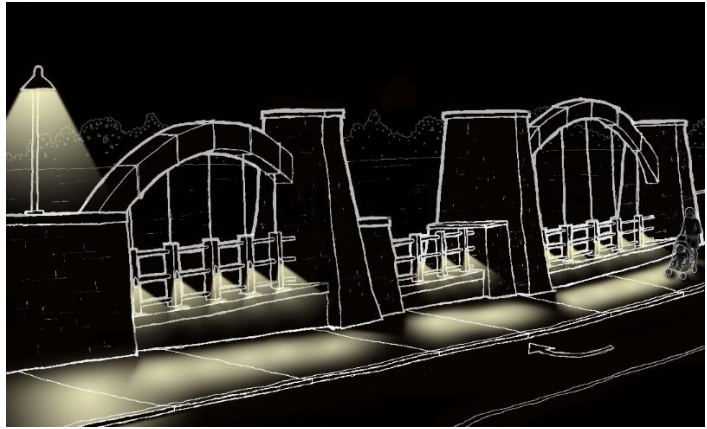

Figure 20: Pedestrian Pathway, Plan View

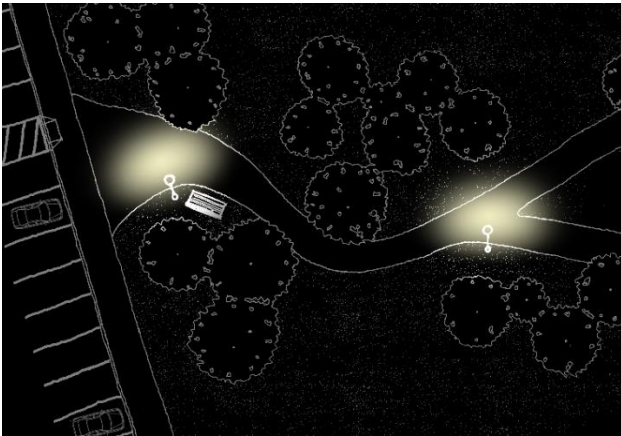

Figure 21: Pedestrian Pathway, Isometric View



2.2.9 CROSSWALKS

When to Light

Mid-block crossings shall always be lighted.

Denoted crosswalks should be lighted whenever possible. Denoted crosswalks include those identified by the use of: signage, flashing beacons, etc. Crosswalks located at roundabouts, near schools, near bus stops, or adjacent to city centers or other areas with anticipated pedestrian use should be lighted. When the crosswalk is within a municipality or metro district boundary CDOT will issue a special use permit for the local agency to assume ownership of the lighting system.

An appropriate lighting design will allow motorists to see pedestrians within the crosswalk.

Lighting Criteria

The lighting levels listed below should be met for both horizontal and vertical lighting in a crosswalk. Lighting levels will be considered as meeting the criteria if the calculated values are within ten percent (10%) of the criteria or do not exceed the criteria by more than two times (2x).

When setting up the crosswalk calculation the horizontal calculation grid should span the entire crosswalk, plus 5 feet within the walkway/approach, at ground level. The vertical calculation grid is to be located 5 feet above finished grade, facing the direction of oncoming traffic. The vertical calculation grid will span all lanes of traffic traveling in a single direction.

Intersecting Street Classification Type	Average Horizontal / Vertical Illuminance with minimal pedestrian activity (fc)	Average Horizontal / Vertical Illuminance with anticipated pedestrian activity (fc)	Horizontal and Vertical Uniformity (avg:min)
Major/Major	1.7 / 1.0	2.4 / 1.2	3
Major/Collector	1.4 / 1.0	2.0 / 1.0	3
Major/Local	1.2 / 1.0	1.9 / 1.0	3
Collector/Collector	1.1 / 1.0	1.7 / 1.0	4
Collector/Local	0.9 / 0.9	1.5 / 1.0	4
Local/Local	0.7 / 0.7	1.3 / 1.0	6
Midblock Crossing	1.9 / 1.0	2.8 / 1.4	4

Best Practices

- Locate luminaires half to one (0.5 to 1.0) pole height before the crosswalk to provide vertical illuminance on pedestrians in the crosswalk.
- Luminaires should not be located above a crosswalk as this diminishes motorists' ability to see pedestrians within the roadway.
- When the roadway curb-to-curb distance is 32 feet or less, and the speed limit is 30 mph or lower, one light standard located along the approach to the crosswalk may be sufficient. To determine this, a single vertical calculation grid should span both directions of traffic from curb-to-curb. If the vertical calculation meets the lighting criteria, then pedestrians should be sufficiently lighted using both positive and negative (silhouette) contrast.
 - Positive contrast is preferred on crosswalks.
 - Negative contrast (silhouette) can allow motorists to detect the pedestrians' silhouetted body against the lighted pavement behind the pedestrian.

DESIGN EXAMPLES

Figure 22: Example 1 Crosswalk, Plan View

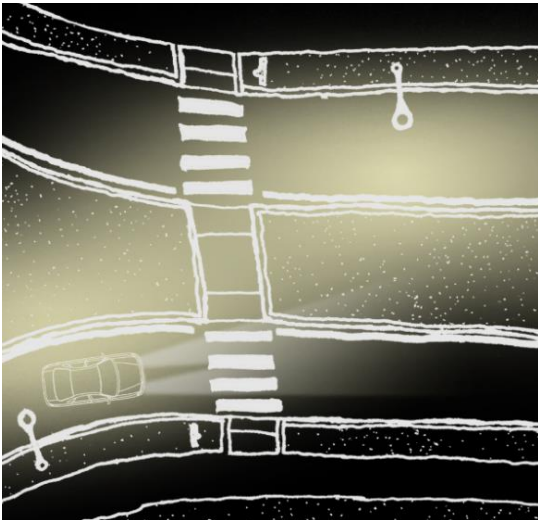

Figure 23: Example 2 Crosswalk, Plan View

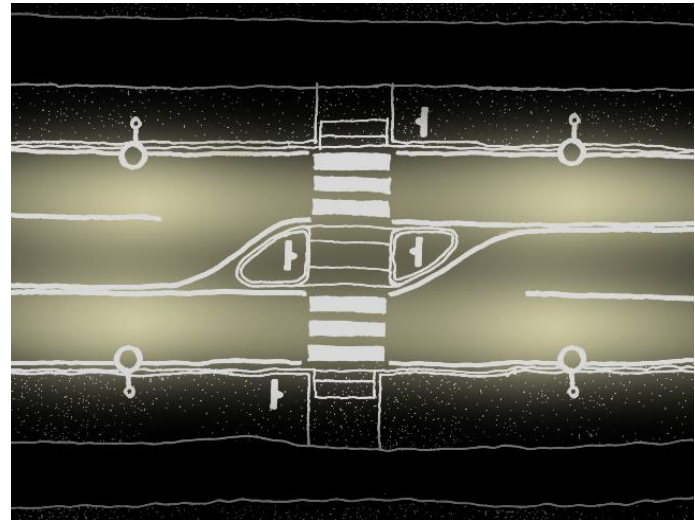
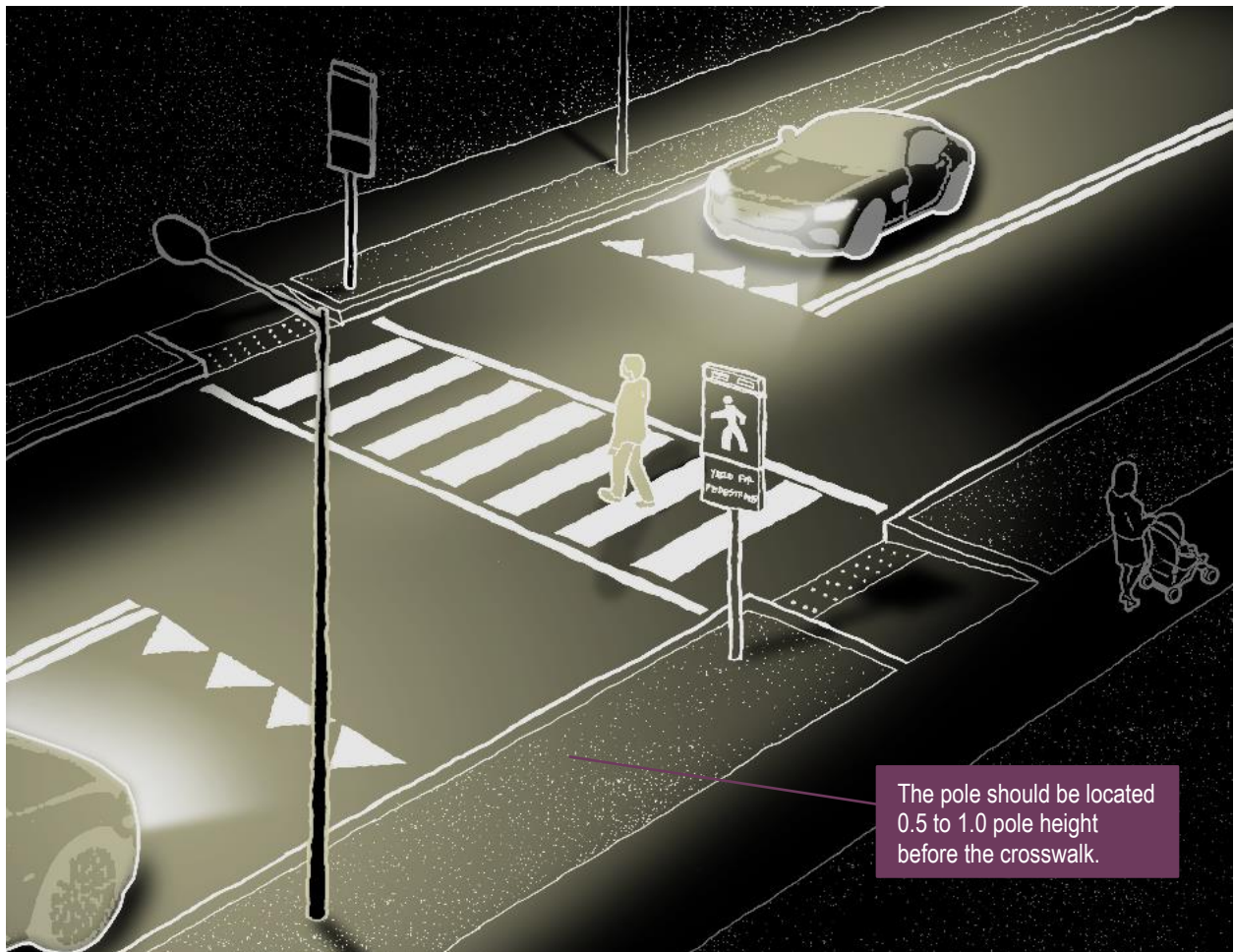

Figure 24: Crosswalk, Isometric View



2.2.10 CDOT PARK AND RIDE FACILITIES

When to Light

- Lighting is justified for all CDOT park-n-ride facilities with adjacent electrical services.
- Activity areas are considered to be bus or light rail loading areas, information centers, and restroom facilities.
- Privately owned park-n-ride facilities should be designed per the standards and guidelines of the local transit authority.
- See IES RP-8-18 chapter 17 for additional information on lighting parking lots and garages. Parking garage entrances and exits require special daytime lighting for motorist adaptation.

Lighting Criteria

Lighting levels will be considered as meeting the criteria if the calculated values are within ten percent (10%) of the criteria or do not exceed the criteria by more than two times (2x).

Location	Average Luminance (cd/m ²)	Minimum Horizontal Illuminance (fc)	Minimum Vertical Illuminance (fc)	Uniformity (avg/min)	Uniformity (max/min)
Entrances, Exits, and Interior Roadway	0.5	n/a	n/a	6	n/a
Parking Lot	n/a	0.2	0.1*	n/a	20
Parking Garage	n/a	1.0	0.5*	n/a	10
Activity Areas	n/a	1.0	0.5	n/a	15
Transaction Machines	n/a	1.0	3.0	n/a	5

*Vertical illuminance is calculated in the drive lanes facing the direction of oncoming traffic.

Best Practices

- Mounting height: Typically, 25 to 30 feet for roadways, 20 to 25 feet for parking lots, and 10 to 15 feet for pedestrian areas. The common mounting height for pedestrian poles is 12 feet.
- Spacing: In parking lots, begin with a 60 foot by 120 foot grid of lights located every other parking row. Modify accordingly to meet lighting criteria and other critical design issues.
- Parking lot lights should be installed every other parking row to provide appropriate light levels.
- When parking lot lights are located in unprotected hardscape areas, they should be located at the junction of parking lot stripping. Parking lot lights should not be located directly in front of vehicles.

Special Considerations

- Locate a light standard before a transit stop to help bus drivers identify potential riders.
- Careful attention should be paid to vertical illumination levels in activity areas. Vertical illuminance is important for identifying approaching pedestrian's gender and intent, to enhance the sense of safety.

DESIGN EXAMPLES

Figure 25: Park-n-Ride, Isometric View



Figure 26: Park-n-Ride, Plan View

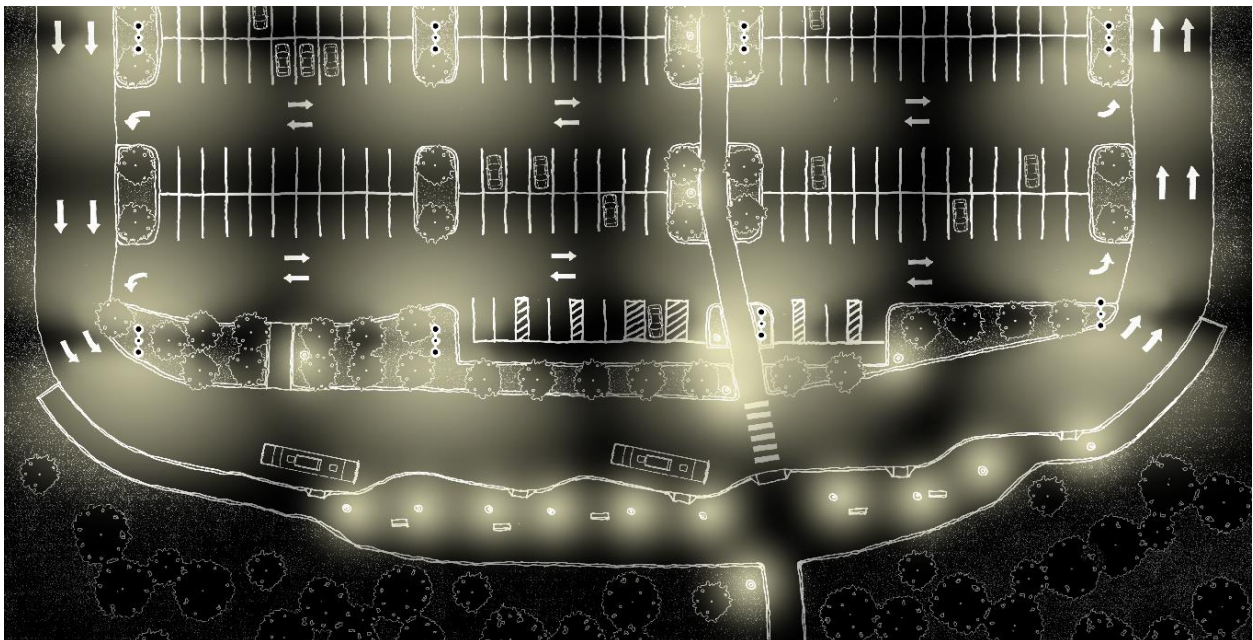

2.2.11 REST AREAS

When to Light

Lighting is justified for any rest area with public facilities with adjacent electrical service. Rest areas located along interstate highways frequently receive heavy usage during evening hours, and motorists tend to avoid them if they are not adequately lighted to ensure comfortable use.

Activity areas are considered to be information centers and restroom facilities.

Lighting Criteria

Lighting levels will be considered as meeting the criteria if the calculated values are within ten percent (10%) of the criteria or do not exceed the criteria by more than two times (2x).

Location	Average Luminance (cd/m ²)	Minimum Horizontal Illuminance (fc)	Minimum Vertical Illuminance (fc)	Uniformity (avg/min)	Uniformity (max/min)
Entrances, Exits, and Interior Roadway	0.5	n/a	n/a	6	n/a
Parking Lot	n/a	0.2	0.1	n/a	20
Activity Areas	n/a	1.0	0.5	n/a	15

Best Practices

- Light areas of high nighttime use and areas to improve users' sense of security.
- Not lighting an area can deter nighttime use in areas where pedestrians are not encouraged to use the space at night.
- Mounting height: typically, 25 to 30 feet for interior roadways, 20 to 25 feet for parking lots and 10 to 15 feet for pedestrian areas. The most common mounting height for pedestrian poles is 12 feet.
- Spacing: begin with a 5:1 spacing to mounting height ratio. Modify accordingly to meet lighting criteria and other critical design issues.

Special Considerations

- If the rest area is adjacent to the main roadway, the roadway should be adequately lighted to minimize excessive contrast and veiling luminance (glare) from the rest area.

DESIGN EXAMPLES

Figure 27: Rest Area, Plan View

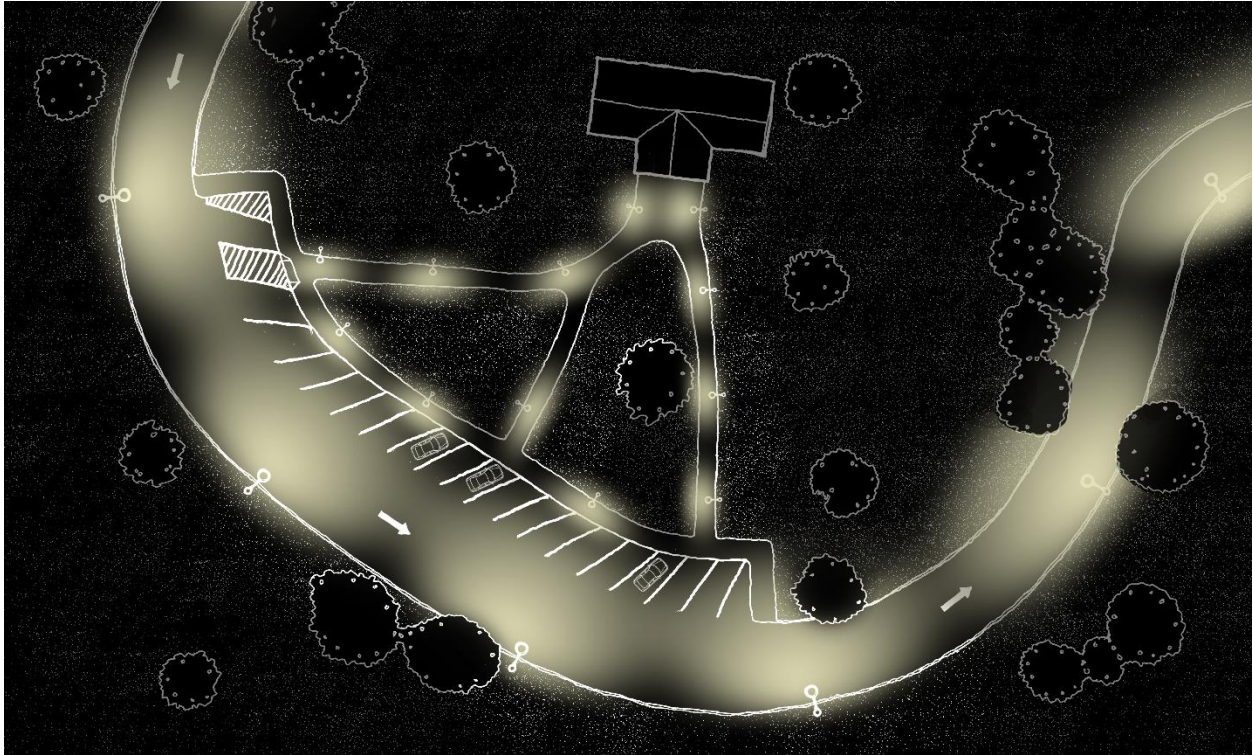
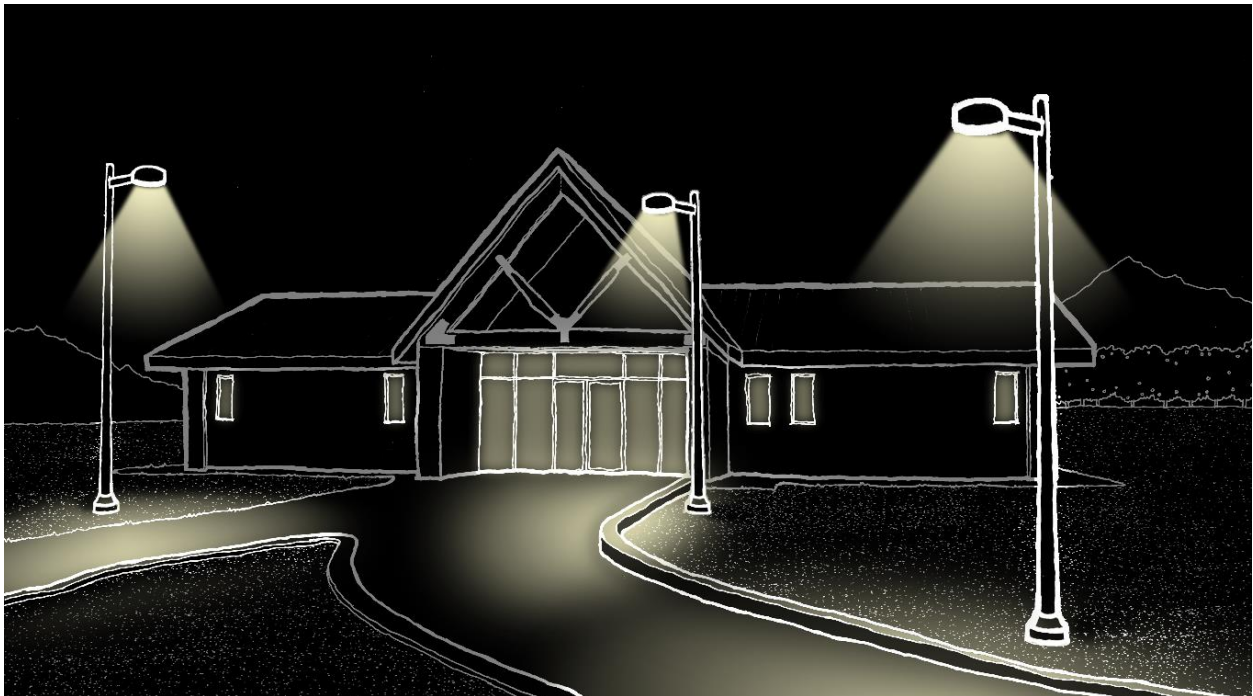

Figure 28: Rest Area, Isometric View



2.2.12 CHAIN-UP AND CHAIN-DOWN AREAS

When to Light

Lighting should be considered at all chain stations. Lighting design should illuminate pedestrians working along the roadside immediately adjacent to traffic.

Lighting Criteria

Lighting levels will be considered as meeting the criteria if the calculated values are within ten percent (10%) of the criteria or do not exceed the criteria by more than two times (2x).

Location	Average Illuminance (fc)	Uniformity (avg:min)
Ground Plane	3.0	2
Vertical (Facing Shoulder)	1.0	2
Vertical (Facing Roadway)	1.0	2
Vertical (Facing Oncoming Traffic)	2.0	4

Best Practices

- Mounting height: typically, 30 to 40 feet for extended (higher, mainline side) luminaire and 20 to 30 feet for lower (shoulder side) luminaire.
- Spacing: A chain station luminaire standard with twin head assembly should be located at each chain station bay. Luminaire spacing is typically 120 feet to denote each bay.

Special Considerations

- Chain stations with uncontrolled access have a higher risk of potential pedestrian conflict, lighting should illuminate the pedestrians working on the trucks along the roadside.
- Add two luminaires per pole, one for each side of the truck as shown in Figure 29. The outside luminaire uses rotatable optics to allow it to aim back at the truck. The BUG ratings should be carefully considered to minimize glare for motorists in the adjacent roadway.
- Install a lighting control system that turns the luminaires “on” when chain up law is activated.
- The lighting control system should be capable of dimming the lights, or increasing light levels if necessary, during bad weather conditions to minimize the glare from light reflecting off of falling snow or fog.

Figure 29: Example Chain Station Lighting Design

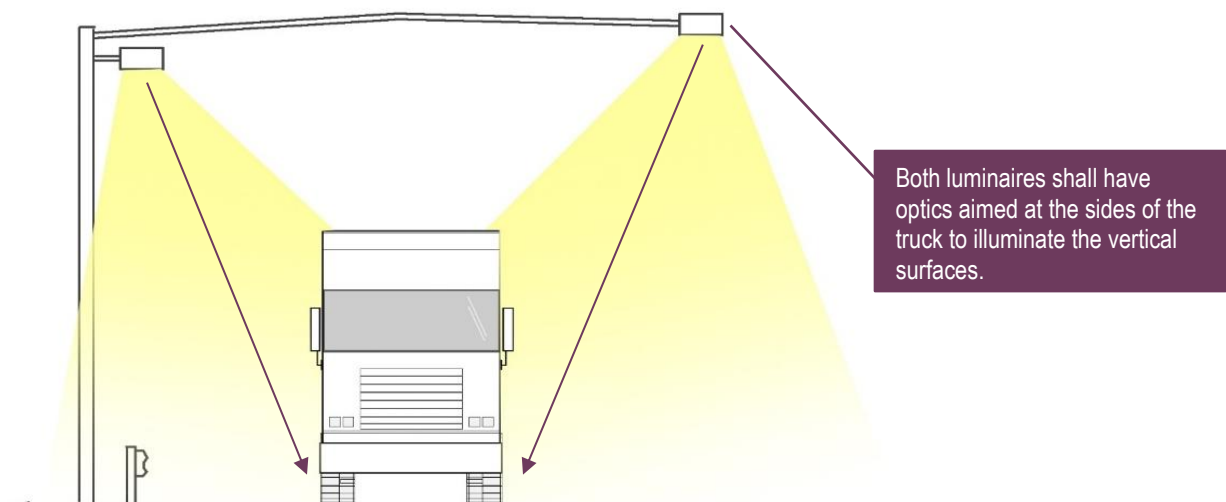

DESIGN EXAMPLES

Figure 30: Chain-up Area, Isometric View

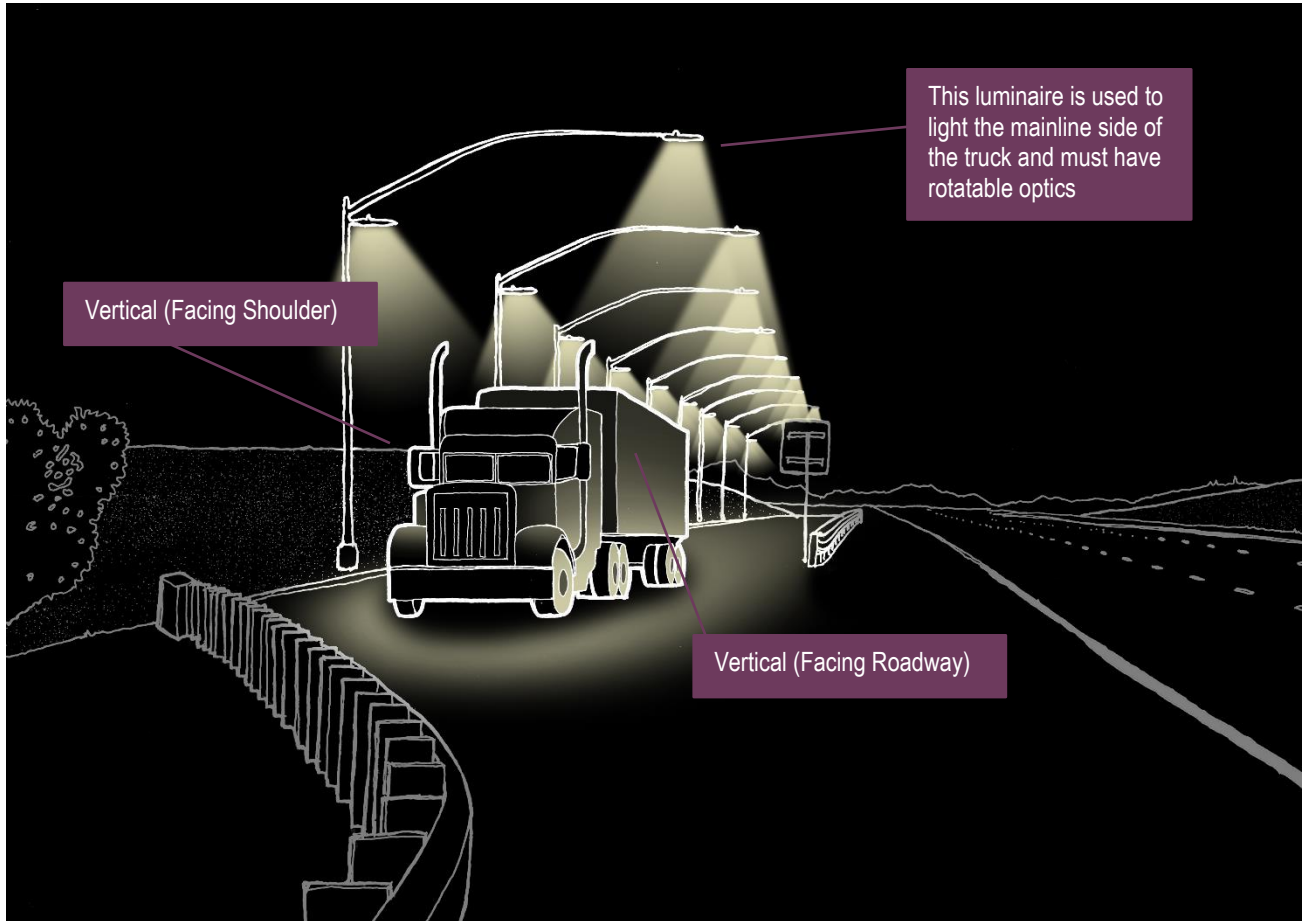
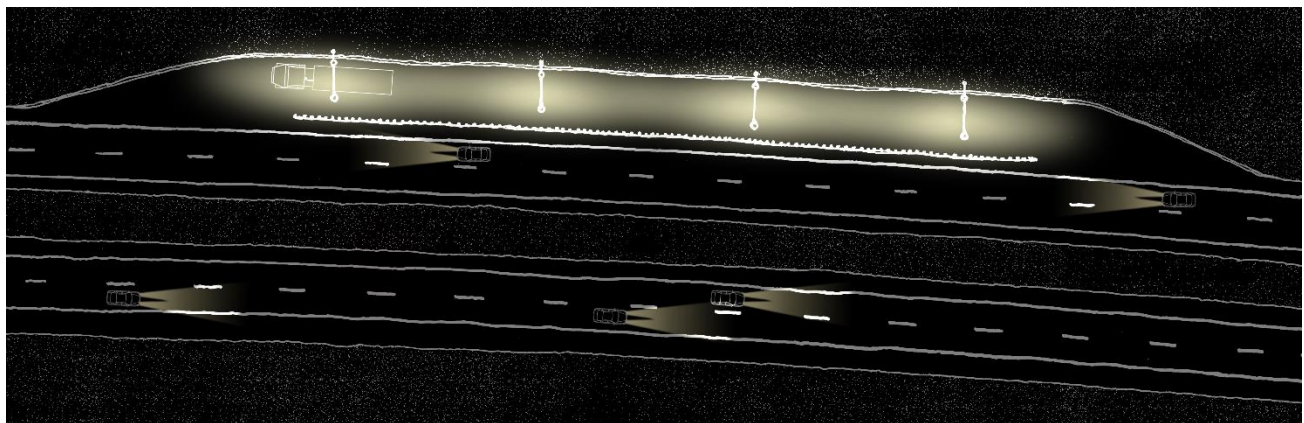

Figure 31: Chain-up Area, Plan View



2.2.13 SOLAR ROADWAY LIGHTING

When to Consider Solar Lights

Solar lighting may be considered at any time when requested by the CDOT Project Engineer. Solar powered systems may be considered for locations where roadway lighting would be beneficial, yet there are either no adjacent power sources or running new electrical conduit and conductors from an adjacent power source is cost prohibitive.

Solar Roadway Lighting Requirements

The lighting criteria shall be per the appropriate special lighting application(s) listed in this guideline. The solar roadway lights must meet the appropriate lighting criteria during the entire nighttime period, from dusk to dawn, during the winter solstice. The illumination level should not vary depending on the battery capacity.

The solar battery system must be designed to provide a minimum of three days of autonomy (no solar input) at the designed light output during the winter solstice for the project location. The battery shall be capable of sustaining a charge at the project locations' average minimum nighttime temperature during the winter solstice. The battery should have a minimum 5-year design life under the conditions listed above.

The solar panel must be located independent of the luminaire. The luminaire must always be installed plumb such that it does not result in any uplight (U0 BUG rating). The luminaire shall meet the requirements listed in CDOT specification 715.

Best Practices

- Mounting height: typically, 20 to 40 feet.
- Solar panels should be oriented south and tilted to maximize solar energy potential.

Special Considerations

- Natural or manmade elements – such as mountains, canyons, trees, bridges, or buildings – may cast a shadow on the solar panel which could minimize the potential solar input during daytime hours. This may reduce the system autonomy and could prohibit the installation of a solar lighting system.
- If adaptive lighting is allowed, ensure that the dimming is activated by either a CDOT approved luminaire control node or programmable sensor and astronomical schedule. The dimming schedule should be independent of the battery capacity.
- Solar panels often have a higher effective projected area (EPA) that may require a larger light standard and foundation than those listed in CDOT standard S-613-1. All solar lighting assemblies should be stamped by a structural engineer licensed in the state of Colorado.
- Solar batteries typically have a five-year design life before they need to be replaced. The purchase and maintenance cost to replace the batteries should be considered prior to installing a solar lighting assembly.
- Solar arrays could be considered to provide power to multiple loads.

Figure 32: Solar Lighting Installation



2.2.14 TEMPORARY ROADWAY LIGHTING

When to light

- Temporary roadway lighting is intended to match or exceed existing lighting levels when existing lighting is removed due to construction.
- Temporary roadway lighting should be considered at the start and end of traffic detour routes.

Lighting Criteria

Lighting levels will be considered as meeting the criteria if the calculated values are within ten percent (10%) of the existing lighting level criteria or do not exceed the existing lighting level by more than three times (3x). When the existing lighting level is unknown, the light level should be selected from the appropriate Lighting Application listed in the previous section; the existing roadway classification should be used to select the lighting criteria.

Location	Luminance (cd/m ²)	Illuminance (fc)
Roadway	Equal to or greater than preconstruction light levels	Equal to or greater than preconstruction light levels
Sidewalk	Equal to or greater than preconstruction light levels	Equal to or greater than preconstruction light levels

Best Practices

- At a minimum, the roadway should be lighted to existing design levels when temporary lighting is applied.
- Temporary lighting can be installed as a one-for-one replacement of existing luminaires.
- Temporary lighting should be considered at the following areas if there is adjacent electrical service:
 - Emergency pull off areas,
 - Lane shifts,
 - Roadway merge and diverge points,
 - Intersections, and
 - Crosswalks.
- The selected temporary luminaire should imitate the existing luminaire lumen output and distribution to appropriately light the roadway.
- Removed luminaires may be reset on temporary light standards to provide temporary lighting.
- Temporary lighting may be cobra heads mounted to wooden utility poles or barrier mounted metal poles.
- Power may be supplied by overhead electrical when a non-breakaway pole is installed.

Special Considerations

- Drive through work areas in both directions to evaluate the level of glare at the time of initial light setup and periodically during the work.
- Temporary lighting must meet all the breakaway requirements that permanent lighting must meet. Non-breakaway poles should be protected by barrier or installed on a barrier.
- When traffic speeds are less than 40 mph, temporary lighting may be installed a minimum of 6 feet behind the front face of curb.

DESIGN EXAMPLES

Figure 33: Temporary Lighting, Isometric View

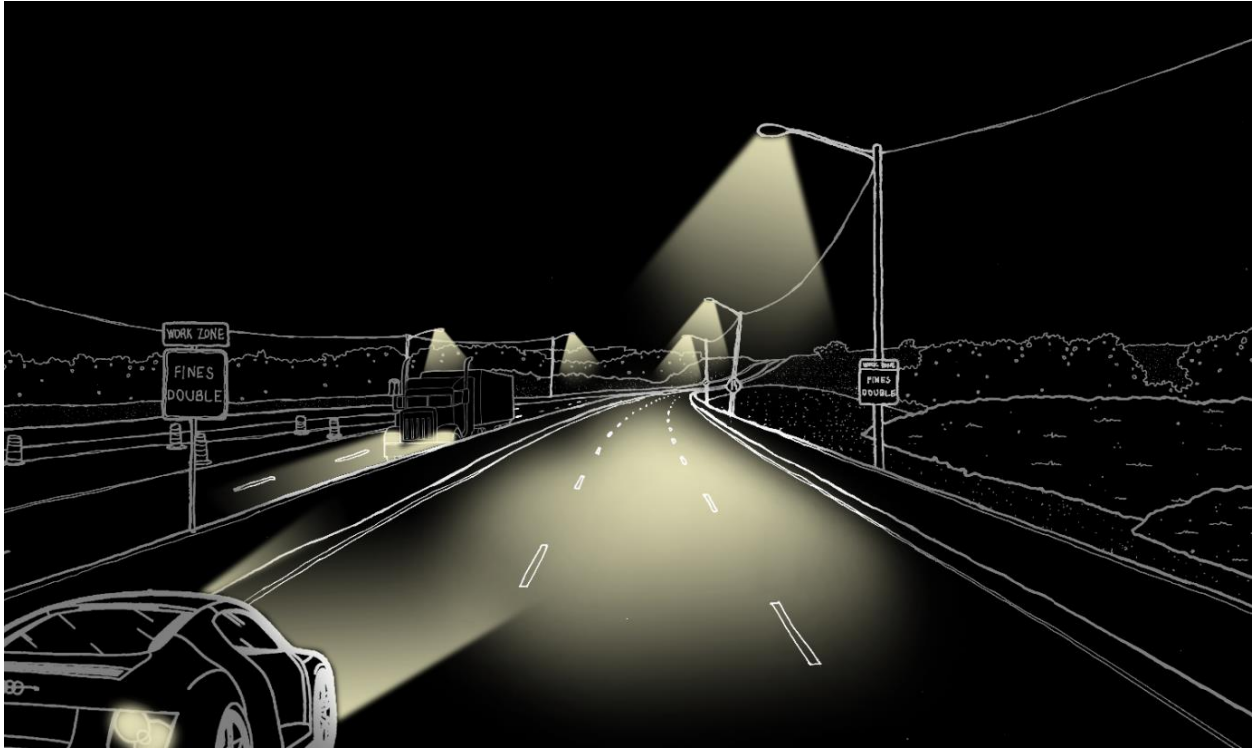
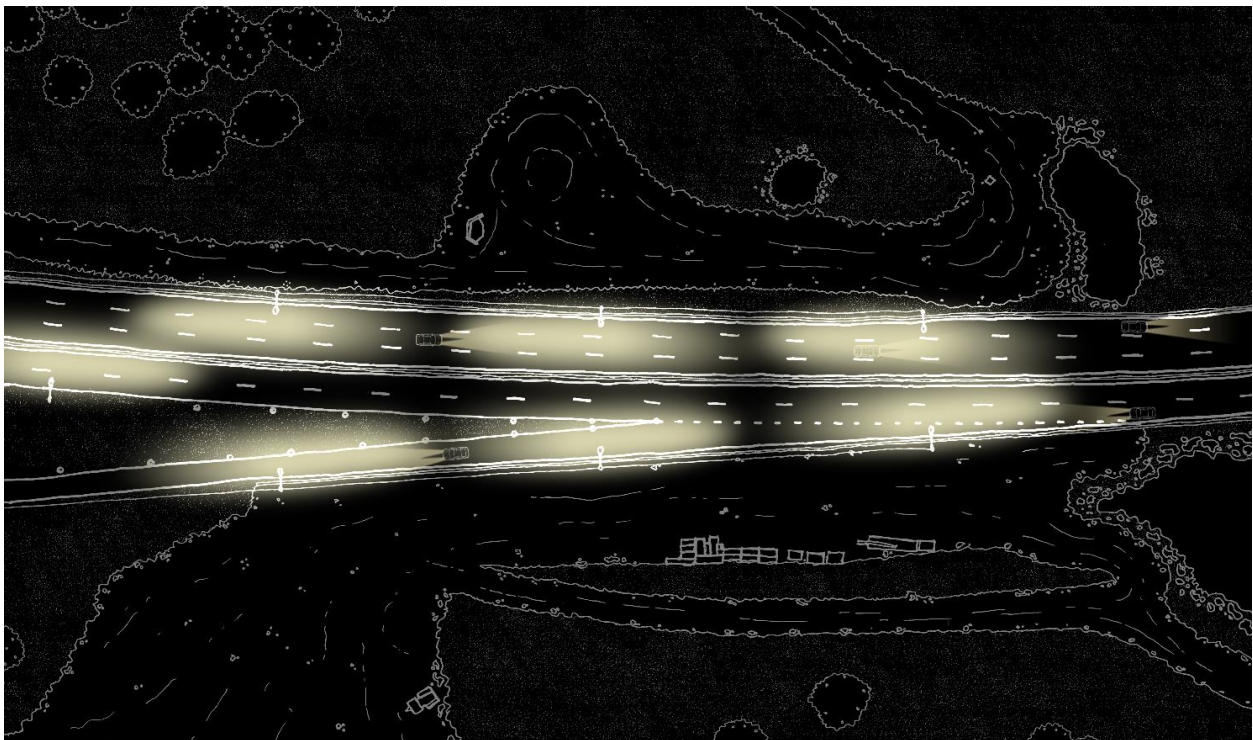

Figure 34: Temporary Lighting, Plan View



2.2.15 TEMPORARY CONSTRUCTION LIGHTING

When to light

From the Manual of Uniform Traffic Control Devices (MUTCD): Any nighttime work shall require lighting of the work area, equipment crossings, and flagger stations.

Lighting Criteria per the MUTCD

The current edition of the MUTCD Section 6 and CDOT Specification 632 must be consulted to determine the appropriate lighting levels for general illumination and precision tasks in the temporary traffic control zone, along the approach to the temporary traffic control zone, and at flagger stations.

Special Considerations

- Temporary streetlights may provide additional light within the work zone, but shall not be used to meet the minimum requirements for traffic control lighting.
- Drive through work areas in both directions to evaluate the level of glare at the time of initial light setup and periodically during the work.
- Construction lights should be aimed at an angle of 60° or less to minimize glare to the motorists, which improves construction worker safety.
- Luminaires should be aimed in the direction of travel to minimize glare to motorists to improve visibility of roadway workers and flaggers.

DESIGN EXAMPLES

Figure 35: Construction Lighting, Isometric View

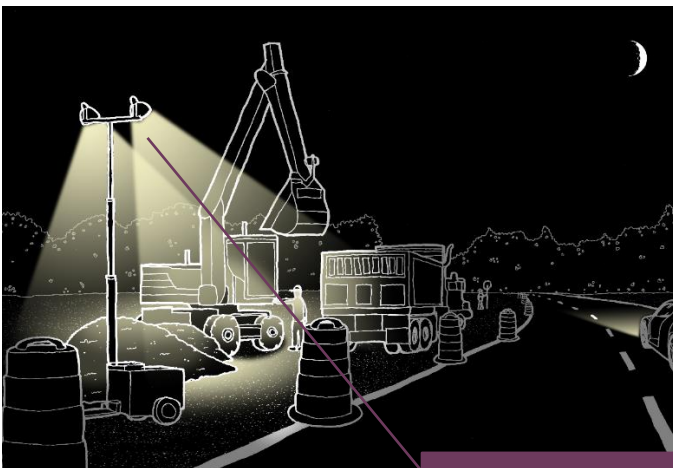
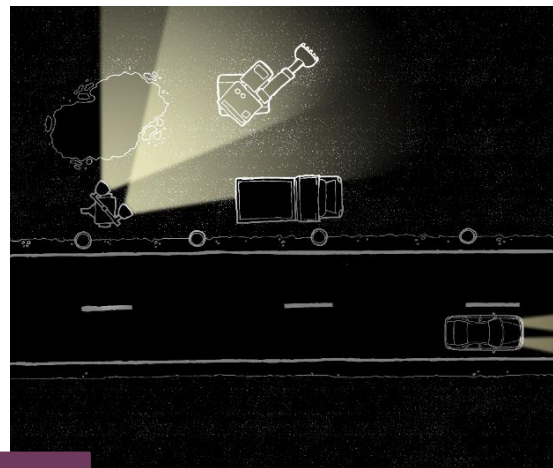

Figure 36: Construction Lighting, Plan View



Construction lights should be aimed at 60° or less to minimize glare to the motorists.

2.2.16 POLITICAL BOUNDARY SIGN LIGHTING

Per the current edition of the *Guide Signing Policies and Procedures*, political boundary Type 3 and Type 4 signs are allowed to be lighted. These signs are provided, installed, powered, and maintained by the local agency at no cost to CDOT. Signs within the clear zone are required to meet breakaway sign standards or be located behind an appropriate barrier.

Type 3 signs are the “decorative” political boundary/ identification signs provided by local governments and installed within the CDOT right of way.

Type 4 signs are the “monument-like” political boundary/ identification markers provided by local governments and installed within the CDOT right of way.

Figure 37: Example of a Type 3 Sign



Figure 38: Example of a Type 4 Sign



When to Light

Lighting may be considered when the local agency will pay for the complete installation of electrical service and lighting for the sign. The local agency is also required to continue to pay for electrical service to power the sign lighting.

Lighting Requirements

- Refer to CDOT Standard Specification 715 for luminaire requirements:
 - CCT: 3000K or less for white light sources.
 - Uplight: U0 rating for lights with 3,200 luminaire lumens or greater.
- Lights shall be fully shielded from the adjacent roadway, including shielded from visibility in motorists’ rearview mirrors.
- Non-white light colors shall not mimic traffic signal colors.
- Sign lighting shall be approved by the CDOT Traffic Engineer.

Maximum Luminance measured on the sign surface (cd/m ²)	
Nighttime Lighting Levels	250
Daytime Lighting Levels	7,500

Best Practices

- Luminaires with more than 1,500 lumens are typically mounted above the light and oriented downward. Luminaires not oriented downward are typically 1,500 lumens or less to minimize sky glow.
- Shielding should be considered for all luminaires, shielding may include:
 - Light sources recessed into the luminaires
 - Honeycomb baffles
 - Louvers
 - Snoots
 - Visors
- Shielding devices should have an internal, matte black finish to minimize potential glare from reflected light.

Figure 39: Example of a Small Floodlight Oriented Downward



Figure 40: Example of a Recessed Light Source



Special Considerations

- Some developments may choose to finance architectural style lighting features such as backlit lettering or details, or grazing sign surfaces. The mounting details for these signs should be carefully coordinated with the local agency.



3. LIGHTING CONTROLS

Lighting controls enable the luminaire light output to be increased or decreased as needed which saves energy, prolongs the life of the luminaire, and can minimize maintenance trips and maintenance time. Simple lighting controls such as astronomical time clocks or LED photocells signal the lights to turn on at dusk and off at dawn. More sophisticated lighting controls can turn the lights on and off, increase or decrease light levels, monitor energy usage, provide asset location, and send maintenance information to appropriate personnel if the luminaire malfunctions.

The project needs should be carefully considered before selecting a control system. Although simple control systems are less expensive to install, the project may benefit from long-term energy and maintenance savings that come with more integrated controls. Even if the project manager decides to forgo controls, the installed luminaire must be future-proofed with a dimming driver and ANSI 7-pin photocell receptacle with shorting cap.

3.1 DIMMING

All CDOT owned and maintained luminaires must have a 0-10V dimmable LED driver or digitally addressable lighting interface (DALI) dimmable driver per the current version of the CDOT Specification Sections 613 and 715. The designer should confirm that the luminaire, LED driver, and control equipment have the same dimming protocol.

0-10V dimming is the most common form of dimming used in exterior applications. The 0-10V dimmable driver within the luminaire modulates the voltage from 0 volts to 10 volts direct current (DC) to vary the luminous intensity of the light source. Most luminaires come standard with 0-10V dimmable driver.

DALI dimming systems are common in Europe and are beginning to gain traction in the United States. DALI control systems provide two-way communication between the luminaire and the control system. Each luminaire can be individually addressable, which means that the luminaire light output can be varied independently of other luminaires on the same electrical circuit.

3.2 PHOTOCONTROL RECEPTACLES AND CONTROL NODES

All CDOT owned and maintained lighting systems should be controlled by either a photocell located on the lighting control center or a CDOT approved control node located on the luminaire.

All installed LED roadway lights, chain station lights, parking lot lights, and lights within rest areas and park-n-rides should have an ANSI 7-pin receptacle on the luminaire to for future control capabilities. If roadway lighting is controlled by a photocell located on the lighting control center (LCC), then the 7-pin receptacle will be covered with a shorting cap. The photocell should only be located on the luminaire when an LCC or centralized lighting panel is not installed. The photocell should always be installed with the window pointed towards the north to minimize sun exposure.

The ANSI 7-pin twist-lock photocell with shorting cap ensures that a CDOT approved control system can be installed on all roadway luminaires. The control node uses three contacts to provide power, two contacts for dimming, and leaves two spare contacts for other sensors and accessories. The control node will be able to remotely control the light level of the lights, monitor energy use, and send a maintenance report if the luminaire malfunctions. The control nodes should be wireless and gateway-less to minimize equipment costs.

3.3 LIGHTING CONTROL CENTERS AND METER POWER PEDESTALS

Lighting control centers (LCC) or meter power pedestals (MPP) are required to provide a location for lighting panels, photoelectric controls (photocells), contactors, maintenance receptacles, and a copy of the electric plans. Each LCC and MPP must be grounded with an approved grounding system. It must also be in an easily accessible location for maintenance and inspection. Many of the LCCs located in the snowy mountain regions have an 18-inch skirt located around the bottom of the LCC to allow the doors to still open without digging the LCC out of the snow. These units should also have an HVAC system installed to control the humidity levels within the LCC in order to prolong the equipment life. The HVAC unit is an optional addition for all regions within Colorado, and is recommended for LCCs with temperature dependent electrical systems.

The CDOT M-613-1 standards and CDOT 613 and 715 specifications should be referenced for additional information on LCC requirements.

Chapter 4



4. LIGHTING FUNDAMENTALS

The purpose of this chapter is to provide a summary of important technical terminology and background information relevant to this Guideline to ensure that CDOT lighting projects are consistently designed. More detailed information can be found in the IES Lighting Handbook, ANSI/IES RP-8-18, and the AASHTO Lighting Guide.

4.1 VISIBILITY

Effective visibility in nighttime environments depends on the control of six different factors: glare, luminance, uniformity, illuminance, contrast, and adaptation. All factors must be adequately addressed to increase visibility.

The ability for motorists and pedestrians to detect objects and other pedestrians to be seen at night depends on task visibility; the task can include seeing obstacles in the roadway, reading street signs, or identifying pedestrians in a crosswalk. The visibility of an object is dependent on the size, brightness, vertical luminance, and contrast of all the objects in an area. Increasing the amount of light (brightness and luminance) that falls on an object increases the task visibility. However, the object brightness must be balanced with its surroundings to prevent glare by being too bright. An example of low task contrast is viewing a barrier indicating a lane shift. The task of driving requires the detection of hazards and a clear view of the surrounding traffic and road conditions. The lighting system may

Figure 41: Components of Visibility

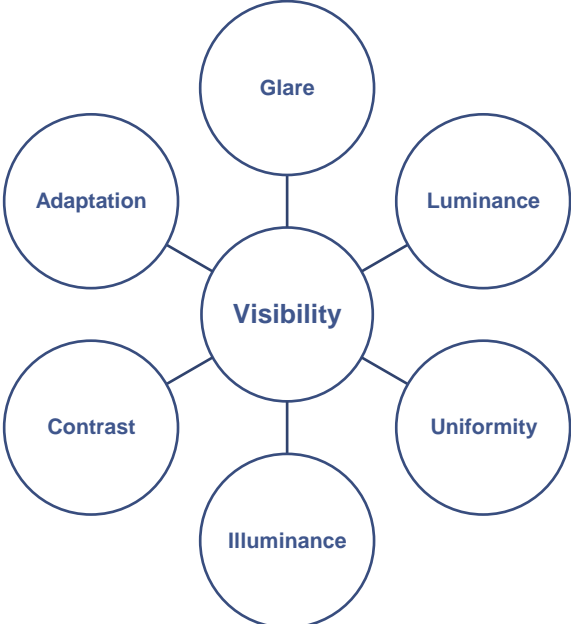

also provide wayfinding by establishing consistent patterns and visual cues, such as a light at the corner of an intersection or in the gore of an off ramp

ILLUMINANCE

Illuminance is the primary lighting metric used for non-roadway applications such as crosswalks, walkways, and bike paths. Illuminance is the amount of light reaching a surface, expressed in units of footcandles (fc), or lux when using the International System of Units (SI units) which is 10.7639 times greater than footcandles, or approximately 10 times greater. Horizontal illuminance refers to the amount of light falling on a horizontal surface, such as pavement. Vertical illuminance is to the amount of light falling on a vertical surface, such as a person, which is critical for drivers to be able to see objects in the roadway.

This metric should only be used for the Lighting Applications that list illuminance criteria such as pedestrian areas, curved roadways, or for vertical illuminance requirements as it does not address surface brightness which a person sees.

LUMINANCE

Luminance is reflected light, or the brightness of a surface or an object in an individual's field of view. It is measured in units of candela per square meter (cd/m^2). This metric is important because, unlike illuminance, luminance best describes what a person or motorist sees.

In roadway lighting, pavement luminance refers to how bright the pavement appears to motorists. When the pavement is under lighted, it is harder to see pavement markings and small objects on the road. Higher pavement luminance provides the driver with visual information on the roadway boundaries, conflict areas such as crosswalks and intersections. More reflective, lighter colored surfaces, such as concrete, reflect more light than darker, less reflective surfaces, such as asphalt; less light is required for more reflective or concrete surfaces to provide the same luminance level.

Veiling luminance is a measure of disability glare and describes how bright the light source is compared to the roadway surface. This is important to consider in roadway lighting designs since glary light sources can inhibit motorists' ability to see objects or pavement markings in the roadway.

Figure 42: Illuminance in a Pedestrian Plaza

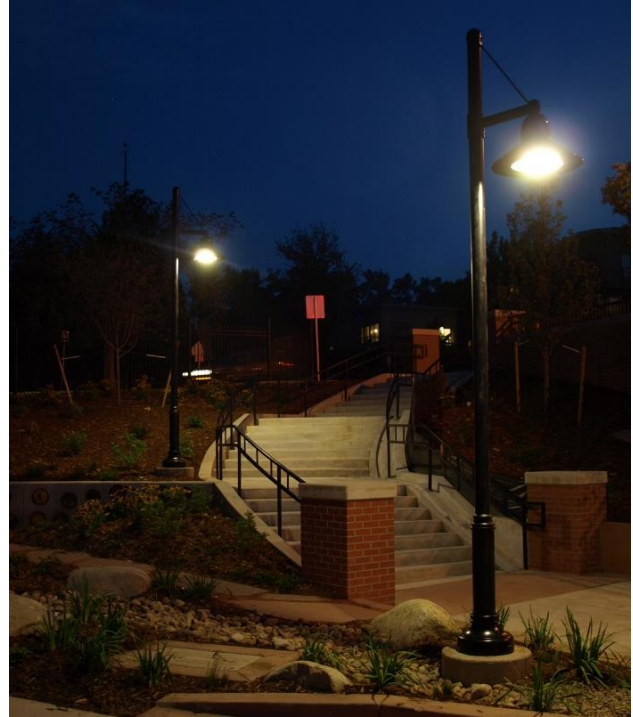
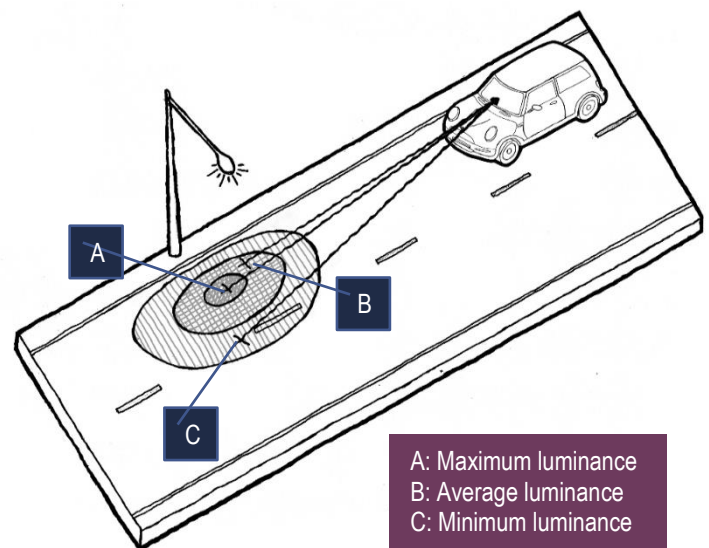

Figure 43: Surface Luminance as Seen by Motorist



UNIFORMITY

Lighting uniformity is defined as the evenness of light. Our eyes are continually adapting to the brightest object in our field of view. Any object lighted to even 1/10 the brightest level of the adjacent surroundings appears noticeably darker. Uniformity that meets the lighting criteria allows the pavement to be evenly lighted. However, too uniform surfaces (less than 2:1 average to minimum) may minimize surface contrast of an object, which can cause some objects to blend into the background, making them harder to detect. A balance is required between uniformity and contrast.

CONTRAST

Contrast is the difference between the luminance values of two adjacent surfaces. High contrast is necessary for good visibility. However, if the contrast becomes excessively high, the brighter surface can become a source of glare.

Surface or object contrast gives motorists the most information for guidance. When contrast is diminished, such as flat daylight on snow packed roads, or when objects on the road have the same luminance as the pavement background, then navigation becomes difficult. It is important to keep strong object contrast for all tasks.

Figure 44: Example of Poor Surface Contrast



Figure 45: Example of Good Surface Contrast



GLARE

Direct glare is caused by excessive light entering the eye from a bright light source. A system designed solely on lighting levels tends to aim more light at higher angles to increase pole spacing, thus producing more glare potential. With direct glare, the eye has a harder time seeing contrast and details, shown in Figure 46. Direct glare can be minimized with careful equipment selection and placement.

To help predict the glare a luminaire will produce, the IES created a luminaire classification system (TM-15-11) called the BUG (Backlight, Uplight, Glare) luminaire rating system. This is covered in more depth in Section 4.3.

Figure 46. Example of Direct Glare



Indirect or reflected glare is caused by light reflecting off the pavement in such a manner that the contrast is washed out. Any light source can cause reflected glare depending on the viewing angle of the motorist. However, streetlights with a high glare-rating (G3 or greater) have an increased potential of reflected glare, especially on wet pavement. Reflected glare will wash out roadway striping, especially on wet pavement, or during inclement weather conditions, and limit one's ability to see contrast. Like direct glare, indirect glare can be minimized with the type and layout of lighting equipment. Direct the light away from the observer with the use of a low G-rated luminaire and installing the luminaire level plumb to the foundation.

LIGHT TRESPASS / LIGHT POLLUTION

Light trespass is often referred to as nuisance glare or the "light shining in my window" effect. Not only does light trespass cause neighbor annoyance, but it also increases light pollution. Refer to ANSI/IES RP-8-18 *Chapter 4 Obtrusive Light* for a complete discussion on minimizing light trespass and light pollution.

Uncontrolled light sources are usually the cause of light trespass. However, even a shielded luminaire may cause light trespass due to the location, height, orientation, and aiming of the luminaire. If the location is not opportune and cannot be changed, additional shielding may be required. The luminaire head should be leveled and plumb with the horizontal, rather than aimed upward or downward.

Over lighting areas will increase reflected light which will result in poor adaptation between the brightly lighted area and adjacent non-lighted areas. Over lighting should be avoided as it increases light trespass and light pollution.

Light pollution, or sky glow, is caused by light aimed directly up into the sky, by light emitted directly at the near-horizontal angles, and by light reflected off the ground or objects. Direct light, rather than reflected light, is the most significant cause of light pollution. Acorn style pedestrian lights, floodlights, wall packs, and other luminaires with uplight components are major contributors to sky glow. Over lighting, even with luminaires that produce little to no uplight, reflects unnecessary light back into the atmosphere and adds to sky glow. Figure 47 shows a view of Denver and the results of uncontrolled light pollution.

Figure 47: City of Denver Light Pollution from Mt. Evans Observatory
©University of Denver – Astronomy Department

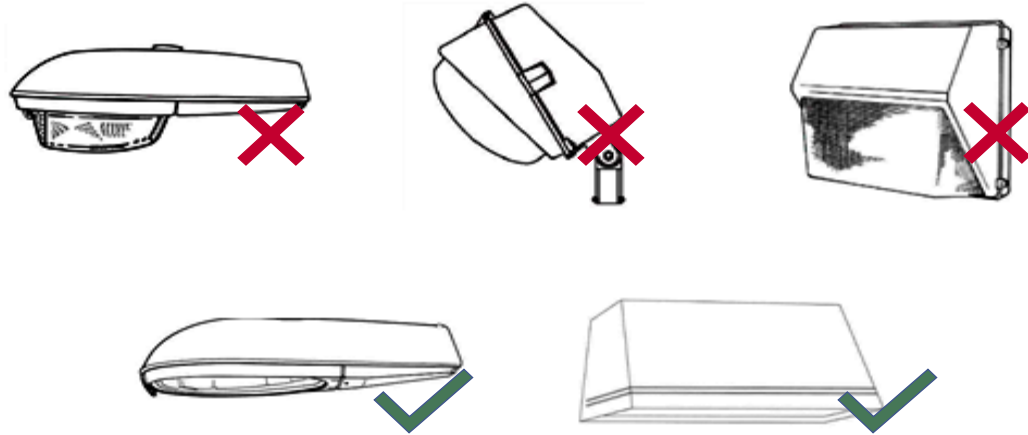

Figure 48: Reduce Glare with Appropriate Luminaires



To minimize light pollution, do not over light areas. Use luminaires with little to no uplight, which will be noted by a U0 rating. Dim lights during periods of lower traffic and reduced pedestrian activities, when snow cover increases pavement reflectance will also reduce light pollution.

Figure 49: No Uplight Luminaires



ADAPTATION

Adaptation refers to the eye's ability to quickly adjust between changes in luminance and intensity. Our eye will automatically adjust to the brightest object in our field of view. Time required for adaptation increases with age due to normal structural and chemical changes in the eye.

Figure 50: Daytime Adaptation



Glare from headlights can affect one's ability to adapt to a lower intensity of light. Additionally, adaptation occurs when driving from a lighted area to a non-lighted section of roadway. For example, transitions into tunnels are critical during the day as well as at night.

VISION

There are three different types of visual responses: Photopic (our day vision), scotopic (our night vision), and mesopic (a combination of night and day vision). Exterior lighting normally falls within the mesopic range. Since our eyes respond to varying colors of light differently, white light sources are recommended to improve visibility.



NON-VISUAL EFFECTS OF LIGHT

Light at night has been shown to disrupt animal communities by impacting normal breeding, migration, feeding, and animal social interaction. Electric lighting has also been shown to impact plants' growth patterns since they need sunlight during the day and darkness at night to sustain a healthy life cycle. Electric lighting at night should be reduced or turned-off whenever possible to minimize the impact to the nighttime environment. Refer to IES RP-33-14 for more information.

4.2 COMMON LUMINAIRE CLASSIFICATIONS

Exterior pole mounted luminaires are classified by the type of light distribution, which refers to the illuminance pattern produced on the ground. Table 1 shows the five basic distribution types.

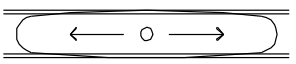
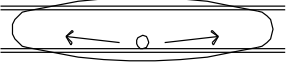
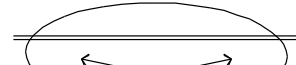
Table 1: Horizontal Distribution Types

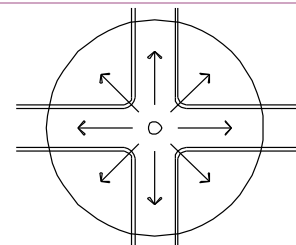
Distribution	Description	Plan View
Type I	Narrow illuminance pattern. Not widely used in roadway applications. Commonly used on multi-use paths.	
Type II	Slightly wider illuminance pattern. Commonly used on single lane or two-lane roadways.	
Type III	Wide, asymmetrical illuminance pattern. Commonly used on roadways.	
Type IV	Widest, asymmetrical illuminance pattern. Commonly used on intersections and parking lots.	
Type V	Symmetrical circular illuminance pattern. Commonly used in the center of parking lots or in pedestrian plazas.	

4.3 BUG RATINGS

The luminaire BUG (Backlight-Uplight-Glare) rating system, as defined in IES TM-15-11, provides a numerical rating of the luminaire light distribution as it applies to backlight (light trespass), uplight, and glare. BUG ratings are defined by the initial lumen output within the distribution angles of the luminaire. In general, a higher BUG rating means that more light is emitted in each angle. The selected luminaire must not exceed the BUG rating requirements (example: B1-U0-G1) listed in the CDOT Standard Specification Section 715.

Per Colorado Statue Title 24 (24-82-902) “All outdoor lighting fixtures with a rated output greater than three thousand two hundred lumens, the fixture is a full cutoff luminaire.” In short, all outdoor luminaires with an initial lumen output equal to or greater than 3,200 initial lumens shall have no uplight (U0 rating).

Figure 51: BUG Rating Diagram

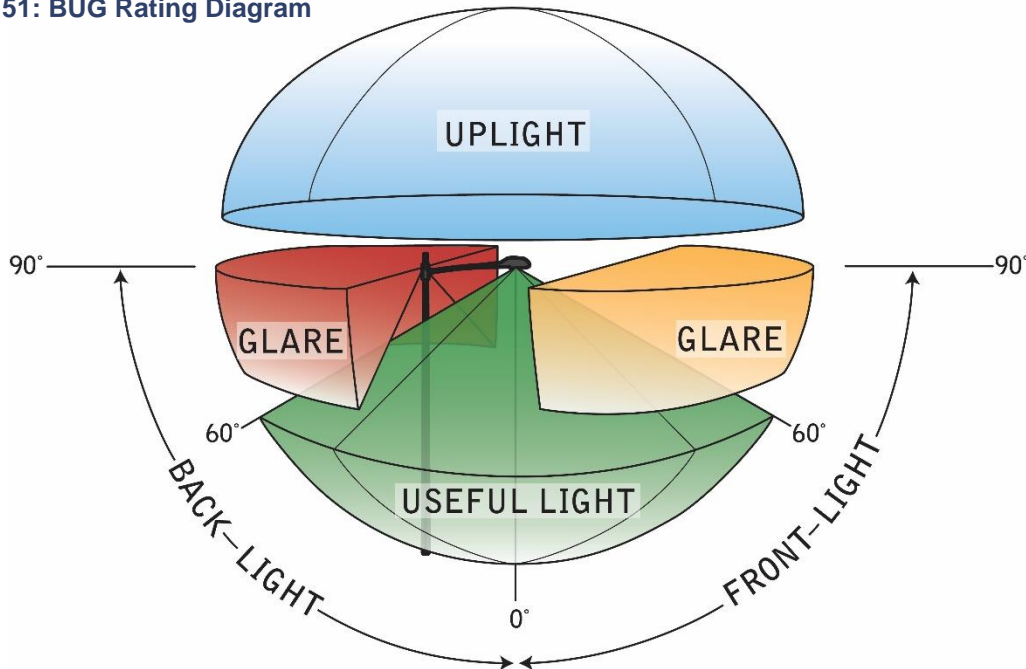

Backlight (B) is the amount of light behind the luminaire. Backlight can result in unwanted light trespass onto adjacent surroundings, or it may provide beneficial lighting for sidewalks behind the amenity zone. The quantity of backlight should be carefully considered in these instances.

Uplight (U) is the amount of light in the upper 90 degrees of the luminaire. Low angle uplight (from 80° to 100°) is the largest cause of sky glow and adversely affects astronomy, smog levels, and the view of the night sky. Higher angle uplight, angles greater than 100 degrees, is generally wasted light.

Glare (G) can be annoying or disabling. While high angles of light allow the light to be distributed further, any angle above 63° can cause disability glare and therefore should be minimized. Luminaires that have a glare rating greater than G4 have the greatest potential for disability glare and are not allowed. Luminaire with G3 glare ratings should only be used in urban applications.

4.4 LIGHTING EQUIPMENT

See CDOT Specifications Section 613 and Section 715 for lighting and electrical requirements.

LIGHT EMITTING DIODES (LEDS)

Light Emitting Diodes (LEDs) are the CDOT standard for new construction and luminaire replacements. The distribution of light in LED luminaires can be tightly controlled by individual LED optics or entire luminaire optics to limit light trespass in locations such as ecologically sensitive, rural, or residential areas. LEDs have extremely long lives (60,000+ hours), consume little energy, and are dimmable. The CDOT LED luminaire specification requires that all installed luminaires have a correlated color temperature (CCT) of 3000K nominal or less unless a deviation is requested (i.e. tunnel applications).

It is recommended that a dimming schedule, otherwise known as adaptive lighting, be created for all exterior luminaires. This dimming schedule will dim the luminaires during nighttime hours when there is minimal traffic (typically 10 pm – 5 am) and higher light levels are not necessary. It can also provide constant light output by dimming the initial luminaire light output to maintained levels when the luminaire is new, thus saving energy.

LEGACY LIGHT SOURCES

Roadways were previously lighted with less efficacious legacy light sources such as high pressure sodium (HPS), metal halide (MH), and induction (Q) lamps. Legacy light sources are no longer allowed per CDOT specifications. CDOT does not allow LED retrofits kits.

POLE MOUNTED EXTERIOR LUMINAIRES

Pole mounted luminaires for exterior lighting come in a wide range of heights and can generally be grouped into one of three categories: pedestrian luminaires, parking lot luminaires, and roadway luminaires. All luminaires mounted on roadway light standards must have a breakaway base, unless the light standard is protected by guard rail or located within one pole height of a pedestrian area or residence.

Pedestrian Luminaires

Pedestrian luminaires light sidewalks, rest areas, and other pedestrian areas. They are typically mounted on 10-foot to 15-foot light standards, with the most common at 12-feet. These luminaires should be shielded to prevent any uplight (maximum U2 BUG rating if the initial luminaire lumen output is less than 3,200 lumens per the Colorado statute).

Parking Lot Luminaires

Parking lot luminaires are typically mounted on 20-foot to 30-foot light standards. These luminaires should be shielded to prevent any uplight (U0 rating), reduce glare (G2 rating or lower), and limit light trespass (B2 rating or lower). If the luminaires are located on the edge of a property line, luminaires with a low backlight rating (B0 or B1) and shielding options should be specified.

Roadway Luminaires

Roadway luminaires are typically mounted on a 25-foot to 40-foot light standard. These luminaires should be shielded to prevent uplight (U0 rating), light trespass (B rating), and maintain a low glare rating (G rating). If roadway luminaires are located near a residential area or another location where light trespass is a concern, a low backlight rating (B0 or B1) should be specified. The light distribution should be carefully selected to meet the lighting criteria.

Figure 52: Pedestrian Luminaires



Figure 53: Roadway Luminaires



POWER SOURCES

LED drivers convert an input voltage to low voltage DC output. Dimmable (0-10V or DALI) drivers must be specified. Legacy lighting power sources (non-LED) are no longer allowed.

LIGHT STANDARDS

Light standard heights are typically determined by the width of the road, light trespass potential, and the standard heights used by CDOT, the utility, or the responsible agency. Typically, the higher the standard, the fewer standards are required for uniform lighting. Standards over 40 feet may increase the light trespass potential; the impact on residential neighborhoods and open space wildlife should also be assessed in these instances.

Round standards should be used since they reflect less light and have lower effective projected areas (EPA). Square section standards should not be used. All light standards must be aluminum or galvanized steel. Every standard must have a handhole or a transformer base. Decorative light standards should only be specified if owned and maintained by the local agency.

High mast standards greater than 70 feet are no longer allowed for new construction projects. CDOT will continue to maintain existing high mast light standards.

Roadway projects that require light standards greater than 40 feet should consider installing mid mast light standards, which are typically 40 feet to 70 feet tall. These standards are typically median mounted to light the entire roadway but may be mounted on the outside of the road.

4.5 DESIGN CONFIGURATIONS

Two design configurations are recommended for use in roadway lighting: opposite and median mounted. Regardless of the configuration used, light standards should be placed in accessible locations, out of a drainage area, and positioned with the luminaire over the shoulder of the road. These locations provide easy and safe access for a maintenance truck with minimal obstruction of traffic. All locations should meet AASHTO's clear zone requirements. Locations need to also meet minimum distance requirements from utility lines per the utility company standards. Final locations must be checked with the traffic, civil, and maintenance teams.

OPPOSITE CONFIGURATION

Opposite configurations refer to pairs of luminaires located on opposing sides of the roadway. This design provides the best visibility.

If the road is narrow (two lanes wide) the lighting criteria may be met by a design with poles on a single side of the roadway.

Figure 54: Opposing Configuration

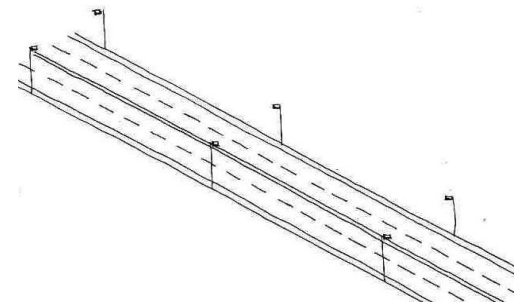

MEDIAN MOUNTED CONFIGURATION

In a median configuration, two luminaires are mounted on a single light standard located in the median of the roadway. Ideally, median mounted standards should be protected by barrier or on a raised median. Median mounted lighting provides a reduced initial cost by eliminating half of the standards needed in an opposite configuration, while minimizing electrical conduit and power supply. It also provides better visibility for guidance around curves.

Figure 55: Median Configuration

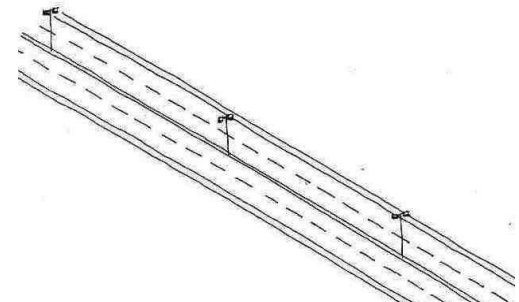

These advantages must be balanced with the fact that these standards may be more difficult to maintain and have a higher potential for light trespass. The luminaires may cause unnecessary glare or higher light levels on surrounding properties since they are aimed towards the outside of the roadway.

STAGGERED CONFIGURATION

Historically, a third configuration, a staggered arrangement, was used. This lighting design is no longer recommended because an opposite arrangement produces better visibility – meaning an object located in the roadway is easier to detect. Figure 56 and Figure 57 depict how the arrangement of the light standards will affect contrast of objects on the roadway. Both negative and positive contrast allow the object to be visible. Neutral contrast causes the object to blend with the surroundings, making it difficult for drivers to identify objects within a stopping sight distance. Avoiding neutral contrast occurrences will increase the visibility of objects in the roadway.

Figure 56: Staggered Pole Configuration

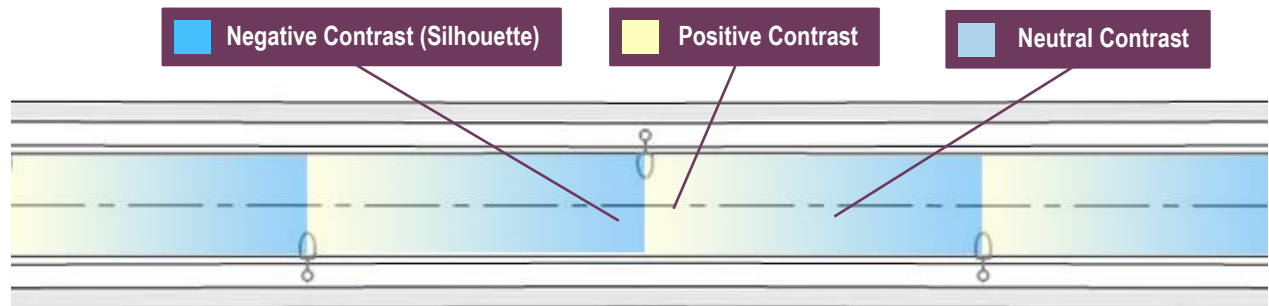
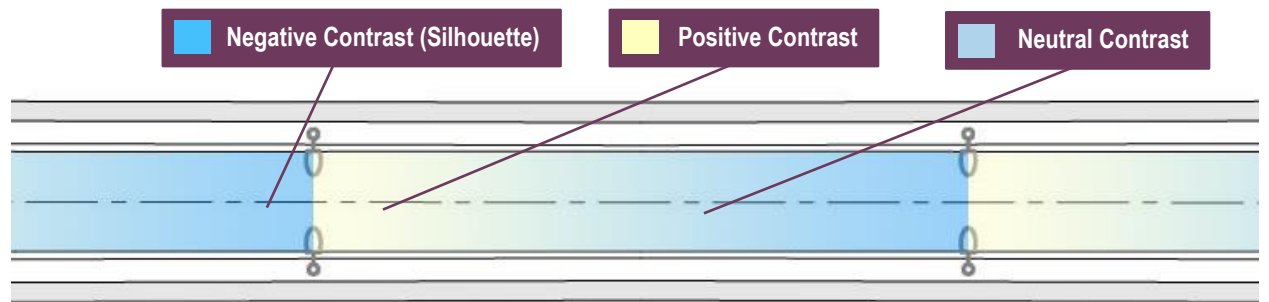

Figure 57: Opposite Pole Configuration



CONTINUOUS LIGHTING

Continuous lighting should be installed when justified on roadways or when the local agency will own and maintain the lights. Continuous lighting is often installed near urban centers or roadways with closely spaced on/off ramps.

Per ANSI/IES RP-8-18, continuous roadway lighting may not be necessary when the posted speed limit is less than 30 mph. At lower speeds, low beam headlights extend the entire stopping sight distance which provides enough time for drivers to identify and react to obstacles in the roadway.

NON-CONTINUOUS LIGHTING

Non-continuous lighting should be installed at conflict areas such as roundabouts, intersections, crosswalks, and interchanges. Along with providing light to improve safety in conflict areas, non-

continuous lighting indicates merge points in the roadway. On/off ramps use non-continuous lighting to provide visual indicators for motorists to follow as the road divides or merges together.

4.6 PEDESTRIAN AREA CLASSIFICATION

Since CDOT only maintains locations outside of incorporated cities or towns, less than 100 pedestrians are anticipated to be found within a stretch of 660 feet, during one hour of darkness in a CDOT maintained area. Due to this, the ANSI/IES RP-8-18 pedestrian conflict classifications have been identified as the following:

- Minimal Pedestrian Activity, which are referred to as low pedestrian conflict areas in ANSI/IES RP-8-18. Less than 10 pedestrians are anticipated to be in this area during one hour of darkness.
- Anticipated Pedestrian Activity, which are referred to as a medium pedestrian conflict area in ANSI/IES RP-8-18. Between 10 and 100 pedestrians may use this area during one hour of darkness.

High pedestrian conflict areas are typical of downtown city centers where more than 100 pedestrians will be found within a 660 foot stretch of roadway during one hour of darkness. These areas may be found in urban cities which fall under the local agency's jurisdiction.

4.7 CALCULATION PARAMETERS

Luminance and illuminance calculations can be used to determine the effectiveness of a roadway lighting design. Lighting calculation programs perform point-by-point calculations to determine luminance and illuminance averages, minimums, maximums, uniformity ratios, and veiling luminance. These programs allow the testing of multiple design strategies and may include tools specifically designed for roadway lighting optimization.

Lighting calculation programs vary with regards to their user interface, but every program will ask for a consistent set of parameters. The user must define the project area, establish the grid(s) of calculation points, import luminaire data, and layout luminaire locations. The program should then calculate the luminance of each point in the grid as seen from the motorist's perspective. An average luminance value is taken across the entire grid of calculation points. It is important to understand that the calculated luminance is dependent on the direction of the motorist and should only include lanes with the same direction of travel.

PAVEMENT CLASSIFICATION TYPES

The following are pavement classification definitions per the Commission Internationale de l'Eclairage (CIE) four class system. The classification is based on the reflective and specular properties of the pavement.

R1 (Concrete): Portland cement concrete road surface; most diffuse pavement reflectance.

R2: Asphalt surface with a gravel aggregate; mixed diffuse and specular surface (not commonly installed in the United States of America).

R3 (Asphalt): Most common asphalt roadway type with dark aggregates; slightly specular.

R4: Asphalt road surface with very smooth texture; most specular.

LIGHT LOSS FACTOR FOR LED

A light loss factor should be applied to every calculated luminaire to ensure that the maintained light levels will meet the lighting criteria. Roadway lighting systems should be designed for the amount of light that will be generated near the end of the life expectancy of a luminaire and the

amount of dirt depreciation that can be expected depending upon environmental conditions. Refer to ANSI/IES RP-8-18 *Chapter 3* for more information about light loss factors.

Table 2: LED Light Loss Factors

Light Source	Luminaire Dirt Depreciation (LDD)	Luminaire Lumen Depreciation (LLD)	Total Light Loss Factor (LLF)
LED	0.9	0.9 ¹	0.81 ²

CALCULATION PROCESS FOR CONTINUOUS STRAIGHT STREETS

The design process for improving or installing street lighting is outlined below:

1. Determine the design parameters of the new street, including: median width, luminaire setback, curb to curb width of the street, number of lanes in each direction, bike lane width, presence of on-street parking, and width of the shoulder.
2. Determine the street classification and level of pedestrian conflict for the street. If pedestrian activity levels vary over the course of the evening, an adaptive lighting (dimming) schedule may be used. When designing lighting for an intersection, determine the street classification of the intersecting street as well.
3. Determine the applicable lighting criteria per the special lighting applications.
4. Select an appropriate luminaire based on the lumen output and maximum BUG ratings.
5. Select an appropriate luminaire CCT (3000K unless a deviation is approved).
6. Develop a model of the street with the design parameters in lighting calculation simulation software such as AGi32, DIALux, or Visual.
7. Set up a luminance calculation grid for one luminaire cycle in the travelled way. On street parking, and shoulders are not included in the travelled way. If the spacing of the lights are irregular, then the designer should consider extending the calculation area to include the whole street segment.
8. Dedicated bike lanes within the roadway should be treated like a drive lane and calculated per the same parameters as the other drive lanes.
9. Begin placing luminaires on the straight continuous lighted street. Evaluate the outcomes of varying street light arrangements to achieve an appropriate spacing. The streetlights should be arranged in an opposite layout to minimize neutral contrast and allow for the greatest visibility. If an opposite arrangement is not possible due to how narrow the curb to curb width of the road is, then a single sided arrangement is recommended. A staggered arrangement should only be selected as a last resort for new construction projects. Although the luminance calculation grid includes only one cycle of luminaires (or straight stretch of street), include additional luminaires in each direction of travel in the model, if the luminaires have significant contribution.
10. Revise the lighting layout in correspondence with other roadway design elements e.g. clearance from driveways (10 feet commercial and 5 feet residential), fire hydrants (5 feet), and trees (centered in between trees or 20 feet from the tree trunk), and avoid locations in front of doorways, windows, and lines of egress.
11. If the calculated luminance meets the average target criteria luminance and uniformity ratio, then the luminaire is a viable option.
12. If necessary, adjust the luminaire spacing and/or lumen output and distribution. Repeat until the values meet the target criteria.
13. Develop an adaptive lighting schedule to account for low traffic periods of the night.

¹ Use 0.9 or LM value provided by the Manufacturer at 60,000 hours, if L70 is greater than 100,000 hours

² If using an LM value provided by the Manufacturer, the Total LLF is equal to 0.9 x LM60,000hr

4.8 MAINTENANCE AND ECONOMICS

LUMINAIRE MAINTENANCE

With the large increase in the availability and affordability of LED light sources comes new maintenance concerns. LED light sources have a rated life of 60,000 hours or more before the light output has decreased to 70% of the original light output. Unlike legacy light sources, when an LED luminaire fails, there is not a typically a lamp or LED board that can replace the failed light source. CDOT Standard Specification Section 613 specifies that all LED light sources comply with warranty requirements to ensure that, should an LED light source fail early in its life, the manufacturer will assist with the replacement of components or the entire luminaire head.

To improve maintenance, the responsible agents in charge of maintaining the luminaire should be involved throughout the design process. This will ensure that the party responsible for maintenance and operation of the lighting system is aware of the design intent and requirements.

INVENTORY MINIMIZATION

Luminaire types and accompanying control systems should be consolidated across lighting applications within a region to minimize the number of various components that need to be stocked by the maintenance team. Components that are stocked by the maintenance team include luminaire heads and long-life LED photocells. Although the LED driver might fail before the LED light source, drivers should not be stocked by the maintenance department. When a driver fails, a new driver that has been UL laboratory tested with the installed luminaire should be ordered from the manufacturer.

Chapter 5



5. GLOSSARY AND REFERENCES

5.1 GLOSSARY

Following are general definitions used in lighting design and this Guideline. Much of this terminology is covered in detail in Chapter 3 and Chapter 4.

Adjacent Electrical Service – Any section of roadway or any area with electrical service location within one mile of the Project, such that electrical service can be delivered to the project site.

Autonomy – Refers to the autonomy of a solar powered system. It is defined as the number of days of operation during which the load can be powered by the battery’s highest rate of discharge without any additional solar inputs before exceeding the battery’s designed maximum depth of discharge.

Bikeway – Any road, street, path, or way that is specifically designated as being open to bicycle travel, regardless of whether such facilities are designed for the exclusive use of bicycles or are to be shared with other transportation modes.

BUG (Backlight, Uplight, Glare) Rating – The quantity of light within various luminaire beam angles.

Backlight – the percent lamp lumens or the luminaire lumens distributed behind a luminaire between zero degrees vertical (nadir) and 90 degrees vertical.

Uplight – the percent lamp lumens or the luminaire lumens distributed above a luminaire between 90 and 180 degrees vertical.

Glare – the percent lamp lumens or the luminaire lumens distributed between 60 and 90 degrees vertically in front of the luminaire.

Candela (see luminous intensity), (cd) – The unit of luminous intensity.

Complete Interchange Lighting – A lighting system that provides relative uniform lighting within the limits of the interchange, including: main lines, direct connections, ramp terminals, frontage road or crossroad intersections.

Continuous Lighting – When uniform light levels are provided by luminaires spaced an equal distance apart along a roadway.

Correlated Color Temperature (CCT) – The absolute temperature of a blackbody whose chromaticity most nearly resembles that of the light source.

Crosswalk – Any portion of a roadway at an intersection or elsewhere distinctly indicated as a pedestrian crossing by lines on the surface, which may be supplemented by contrasting pavement texture, style, or color.

Dimming Protocol – The control standards that vary the luminaire intensity.

0-10V Dimming – A unidirectional analog lighting control protocol. The 0-10V control applies a voltage between 0 and 10 volts DC to vary intensity levels. Although there is no light output when the voltage is at 0, power is still supplied to the luminaire. A switching device or separate relay is required to turn the luminaires off.

Digital Addressable Lighting Interface (DALI) – A two-way digital control protocol that can individually address each luminaire or control luminaire groups.

Disability Glare – Also referred to as veiling luminance, it is a luminance superimposed on the retinal image that reduces its contrast. It is this veiling effect produced by bright sources or areas in the visual field that results in decreased visual performance and visibility.

Discomfort Glare – Glare that produces discomfort but does not necessarily diminish visual performance.

Driver (LED Driver) – A device composed of a power source and light emitting diode (LED) control circuitry designed to operate and dim an LED light source.

Expressway – A divided highway with partial control of access.

Footcandle (fc) – A unit of illuminance. One footcandle is 10.7639 lux, which is the SI unit of illuminance.

Flyover – A high-level overpass, built above main overpass lanes, or a bridge built over an at-grade intersection.

Freeway – A divided highway with full control of access.

Freeway A – Roadways with great visual complexity and high traffic volumes. Usually this type of roadway will be found in major metropolitan areas in or near the central core and will operate at or near design capacity through some of the early morning or evening hours of darkness.

Freeway B – All other divided roadways with full control of access.

Glare – The sensation produced by luminance within the visual field that is sufficiently greater than the luminance to which the eyes are adapted to cause annoyance, discomfort, or loss in visual performance (disability glare) or visibility.

High-Mast Lighting – Illumination of a large area by means of a group of luminaires that are designed to be mounted in a fixed orientation at the top of a high mast light standard with lowering devices, generally 70 feet or higher. New high mast lights are no longer installed by CDOT.

Illuminance (footcandle, fc) – The incident light falling on a surface such as roadway pavement. The source of light may include the roadway luminaires, automobile headlights and other nearby lighting equipment. Total illuminance at a point is a combination of all light sources that contribute. Units in footcandles (fc).

Initial Illuminance (footcandle, fc) – The amount of horizontal illuminance on the pavement area at the time the lighting system is installed, when light sources are new, and the luminaires are clean; units in footcandles (fc).

Isolated Interchange – A grade-separated roadway crossing with one or more ramp connections between the crossing roadways, which is lighted and is not part of a continuous roadway lighted system.

Isolated Intersection – A lighted area in which two or more non-continuously lighted roadways join or cross at the same level.

Light Loss Factor (LLF) – A depreciation factor that describes the drop in light output over the life of the system. The total LLF is determined by a combination of factors, such as lumen depreciation and luminaire dirt depreciation.

Light Standard – A light pole, the supporting member for a luminaire.

Lumen (lm) – The luminous flux emitted within a unit solid angle by a point source (one steradian) having a uniform luminous intensity of one candela (cd). See luminous flux.

Luminaire – A complete lighting device consisting of the light source, lens, reflector, refractor, 7-pin receptacle, housing and such support as is integral with the housing. If the dimming driver is located within the housing, it is considered integral and therefore part of the luminaire. The pole, posts, and bracket or mast arm are not considered to be part of the luminaire.

Luminaire Efficacy – Efficacy is the lumen output of the luminaire divided by the total luminaire power input expressed in lumens per watt. It is a measure of how energy efficient luminaires are compared to alternative luminaires.

Luminaire Lumens – The amount of light delivered by the luminaire.

Luminance (candelas per square meter, cd/m^2) – The luminous intensity of any surface in a given direction per unit of projected area of the surface as viewed from that direction; i.e., the apparent brightness of a surface.

Luminous Flux (lumen, lm) – A unit of measure of the quantity of light. One lumen is the amount of light that falls on an area of one square meter, every point of which is one meter from a source of one candela. A light source of one candela emits a total of 12.57 lumens. Light sources are rated in terms of luminous flux.

Luminous Intensity (candela, cd) – The candela is the basic unit of light quantity. The candela is historically related to the light emitted by a candle flame and was previously known as candlepower. The candela can be thought of as the number of photons per second emitted by the light source. (A photon is a subatomic particle with zero mass that carries the energy of light and all other forms of electromagnetic energy.)

Lux (lx) – The SI unit of illuminance. One lux is equal to one lumen per square meter (lm/m^2), 10.7639 lux is equal to one footcandle (fc).

Maintained Illuminance (footcandle, fc) – The average level of horizontal illuminance on the roadway pavement when the illuminating source is at its lowest output and when the luminaires are in their dirtiest condition; expressed in footcandles for the pavement area. This is calculated by multiplying the initial illuminance by a light loss factor.

Median – The portion of a divided roadway physically separating the traveled ways for traffic in opposite directions.

Mesopic Vision – Vision with fully adapted eyes at luminance conditions between those of photopic and scotopic vision. The range of adaptation is between 3.4 and 0.034 cd/m^2 .

Mid-Mast Lighting – Illumination of a medium area by means of a group of luminaires that are designed to be mounted in a fixed orientation at the top of a mid-mast light standard, generally 40 feet to 70 feet high.

Mounting Height (MH) – the vertical distance between the roadway surface and the center of the apparent light source of the luminaire.

Nadir – Nadir is the lowest point on a sphere directly straight down.

Non-Continuous Lighting – When lighting is provided at key locations to improve visibility and wayfinding.

Partial Interchange Lighting – A lighting system that provides illumination only of decision making areas of roadways including: acceleration and deceleration lanes, ramp terminals, crossroads at frontage road or ramp intersections, other areas of nighttime hazard.

Pedestrian Walkway – A public walk for pedestrian traffic, not necessarily within the right-of-way of a vehicular traffic roadway. Included are pedestrian overpasses, pedestrian tunnels, and walkways giving access through parks or block interiors.

Pedestrian Conflict Areas – Location with pedestrian-vehicle interaction. Three classifications of pedestrian night activity levels and the types of land use with which they are typically associated are given below:

High – Areas with significant numbers (over 100 pedestrians an hour) of pedestrians expected to be on the sidewalks or crossing the streets during darkness. Examples are downtown retail areas, near theaters, concert halls, and stadiums. High pedestrian activity is not anticipated for any CDOT maintained areas, refer to ANSI/IES RP-8-18 for more information.

Anticipated Pedestrian Activity (Medium) – Areas where less numbers (10 to 100 pedestrians an hour) of pedestrians utilize the streets at night. Typical are downtown office areas, blocks with libraries, neighborhood shopping, parks, and area with transit lines.

Minimal Pedestrian Activity (Low) – Areas with very low volumes (10 or fewer pedestrians per hour) of night pedestrian usage. A low pedestrian classification can occur in any street classifications but may be typified by suburban streets with single family dwellings, very low-density residential developments, and rural or semi-rural areas.

Photopic – Photopic vision is our day vision. It is color vision provided by cones in the eye, generally associated with adaptation to a luminance of at least 3.4 cd/m^2 .

Scotopic – Scotopic vision is our night vision when lighting is not present. It is black and white vision provided by rods in the eye, and generally associated with adaptation to a luminance equal to or less than 0.034 cd/m^2 .

Shoulder – A paved portion of the roadway adjacent to the edge stripe.

Sidewalk – A paved or otherwise improved area for pedestrian use, located within public street right-of-way, which also contain roadways for vehicular traffic.

Signs, Political Boundary – Refer to the *2019 Guide Signing Policies and Procedures* for political boundary sign regulations.

Type 3 Sign – “Decorative” political boundary/ identification sign provided by the local governments and installed within CDOT right of way.

Type 4 Sign – “Monument-like” political boundary/ identification sign provided by the local governments and installed within CDOT right of way.

Small Target Visibility (STV) – a weighted average of the values of target Visibility Level over a grid of points on an area of roadway for one direction of traffic flow. STV values are typically both positive and negative over an area on the roadway. A value of 1.0 or below (positive or negative)

indicates that the target is below threshold for a standard observer who is allowed a fixation of 0.2 seconds.

Spacing – The distance between successive luminaires, measured along the center line of the installation (roadway, pathway, bridge, etc.).

Street Classification – The street classifications are based on varying levels of access and traffic volumes as noted below:

Major – Principal roadway network for through-traffic flow. The routes connect areas of principal traffic generation and important roadways entering and leaving the city. These routes are often classified as “arterials”, “thoroughfares”, or “preferentials”.

Collector – Roadways servicing traffic between major and local streets. These are streets primarily used for traffic movements within residential, commercial, and industrial areas. Collector streets may be used for truck or bus movements and give direct service for abutting properties.

Local – Local streets are used primarily for direct access to residential, commercial, industrial, or other abutting property. They make up a large percentage of the total street system but carry a small percentage of vehicular traffic.

Tunnel – An enclosure roadway for motor vehicle traffic with vehicle access limited to portals, regardless of the type of structure or method of construction, that requires, based on the owner’s determination, special design considerations that may include lighting, ventilation, fire protection systems, and emergency egress capacity.

Divided Tunnel (Single direction bore) – A structure that consists of two separate enclosures, each designed to accommodate one direction of traffic flow.

Undivided Tunnel (Bi-directional bore) – A structure which consists of a common enclosure to accommodate traffic flow in both directions.

Underpass – A structure whose length and physical configuration do not substantially limit a driver’s ability to see objects ahead.

Uniformity Ratio – Maximum uniformity ratios are used to judge the evenness of the light on the road or sidewalk surface. The most significant uniformity ratios are average to minimum and maximum to minimum.

Veiling Luminance Ratio – Luminance that is superimposed on the retinal image. This describes how bright the light source is compared to the roadway surface. It is important in roadway lighting since light source brightness can inhibit one’s ability to see details or objects on the pavement.

Viaduct – A long bridge-like structure carrying a road across a valley or other low ground.

Visibility – The quality or state of being perceivable by the eye. Visibility may be defined in terms of the distance at which an object can be just perceived by the eye or it may be defined in terms of the contrast or size of a standard test object, observed under standardized view-conditions, having the same threshold as the given object.

5.2 REFERENCES

AASHTO, *Roadway Lighting Design Guide*, American Association of State Highway and Transportation Officials, Washington DC, 2005.

ANSI/IES, *Recommended Practice for Design and Maintenance of Roadway and Parking Facility Lighting 8-18 Lighting for Exterior Environments*. The Illuminating Engineering Society, New York, 2018.

FHWA, *Lighting Handbook*, Federal Highway Administration, Washington DC, 2012.

FHWA, *Manual on Uniform Traffic Control Devices*, Federal Highway Administration, Washington DC, 2009.

IES, *Lighting Handbook, Tenth Edition*, The Illuminating Engineering Society, New York, 2011.

IES, *Recommended Practice 33-11 Lighting for Exterior Environments*. The Illuminating Engineering Society, New York, 2011.

IES, *Technical Memoranda 12-12 Spectral Effects of Lighting on Visual Performance at Mesopic Lighting Levels*. The Illuminating Engineering Society, New York, 2012.

IES, *Technical Memoranda 15-11 Luminaire Classification System for Outdoor Luminaires*. The Illuminating Engineering Society, New York, 2011.

IES, *Technical Memoranda 21-11 Projecting Long Term Lumen Maintenance of LED Light Sources*. The Illuminating Engineering Society, New York, 2011.

IES, *Lighting Measurements Testing and Calculation Grids 79-08 Electrical and Photometric Measurements of Solid-State Lighting Products*. The Illuminating Engineering Society, New York, 2008.